

HDMI Type-D HEAC Test Adapter

User Manual



WILDER
TECHNOLOGIES

It's all about integrity

Table of Contents

Introduction.....	3
Product Inspection	5
The HDMI Type-D HEAC Test Adapter Care and Handling Precautions	6
General Test Adapter, Cable, and Connector.....	8
Handling and Storage	8
Visual Inspection.....	8
Cleaning	8
Making Connections	8
Electrostatic Discharge Information.....	9
User Model	10
Calibration	13
SOLT.....	14
1X-THRU	15
E-EDID/Low Frequency Control Board	16
Mechanical and Environmental Specifications.....	17
Electrical Specifications	20
Wilder Technologies, LLC – Limited Warranty	33
Wilder Technologies, LLC – Terms & Conditions of Sale	34
Compliance with Environmental Legislation	35
WEEE Compliance Statement.....	35
Glossary of Terms	36
E-EDID Addendum A-1.....	37
E-EDID/Low Frequency Control Board reference information.....	37
E-EDID/Low Frequency Control Board User Model.....	40
E-EDID EE-PROM.....	45
Index	51

Introduction

This user's guide documents the HDMI Type-D HEAC Test Adapter (HDMID-TPA) the associated Calibration Module, and the E-EDID/Low Frequency Control Board. The two test adapter types, shown in Figures 1 and 2, test HDMI Interface (HDMI) cables and devices against the HDMI Compliance Test Specification Version 1.4a. The Calibration Module, shown on Page 13, is used to zero-out test adapter attributes (using SOLT, with either the 1X-THRU or the 2X-THRU). The E-EDID/Low Frequency Control Board shown on Page 16, and further discussed in Addendum A-1, provides measurement access to several test points.

The TPA-P and TPA-R test adapter assemblies allow easy access, via SMA connections, to measure or inject TMDS Data and Clock signals and/or HEAC signals. These test adapters also provide access to DDC/CEC signals, including the +5V Power, SDA, SCL, CEC, DDC/CEC Return, and Ground via an eight-position low-speed connector. A mating eight-position low-speed connector is provided on the E-EDID/Low Frequency Control Board for additional access to these signals. Hot Plug Detect, High-Speed Ethernet, and Audio Return Channel are incorporated in the functionality of the HEAC signals. The HEAC coaxial cable shields are DDC/CEC Return referenced as stated per HEAC Table 2-1 of HDMI specification version 1.4a dated March 4 2010. The TMDS signals are high-speed ground referenced.

NOTE: To avoid damaging the cables, use the handling techniques described in the Care and Handling section before making any connections or configuring a test setup.

Always use a static-safe workstation when performing tests, as explained in the "Electrostatic Discharge Information" section.

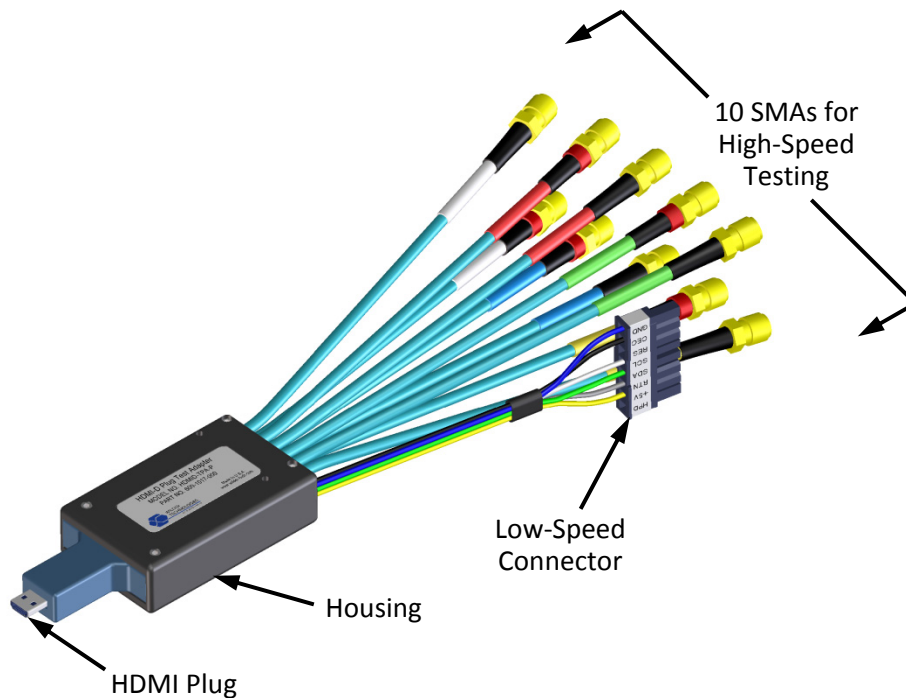

Figure 1. The HDMI Type-D HEAC Test Adapter (Plug)

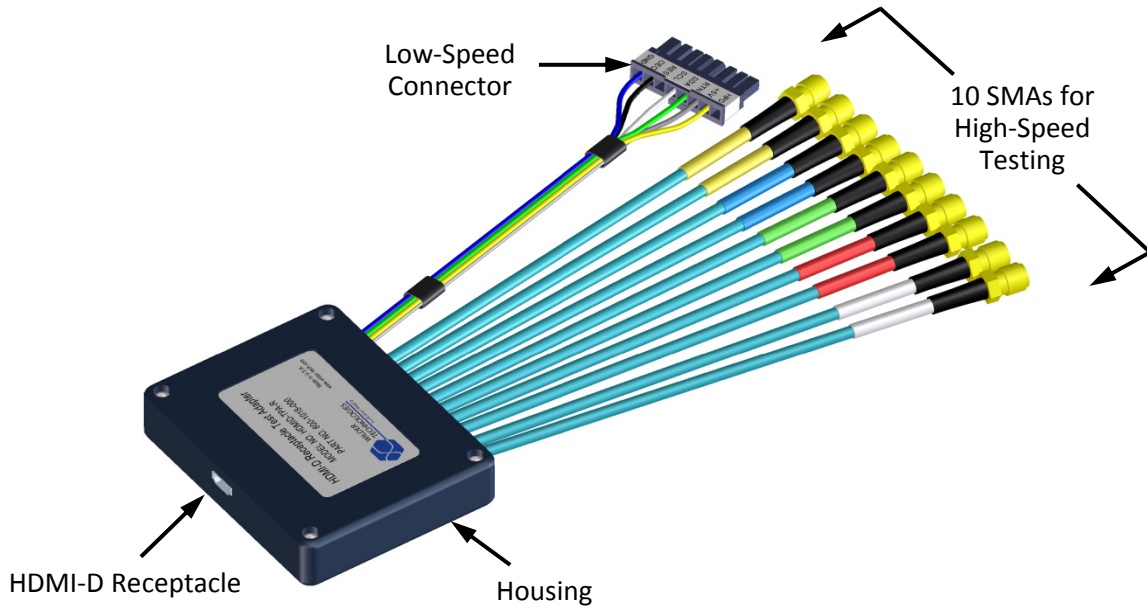

Figure 2. The HDMI Type-D HEAC Test Adapter (Receptacle)

NOTE: The metal shell of both the plug (HDMID-TPA-P) and receptacle (HDMID-TPA-R) connectors are configured at the factory to tie high-speed ground to chassis ground.

The low-speed 8-position receptacle connector is keyed and latching (Molex part number 43645-0800). The mating plug connector housing and contact pins for 26-30awg wire are provided with each HDMID-TPA assembly (Molex part numbers 43640-0801 for the 8-position housing and 43031-0011 for the 26-30awg pin contact). Replacement plug parts can be purchased through Molex distributors.

An adapter cable assembly (P/N 415-0028-000) is included with the HDMID-TPA-E (E-EDID/Low Frequency Control Board) for connecting the HEAC coaxial cables to the EDID board for non-HEAC testing. Contact Wilder Technologies or visit the Wilder Technologies web site for additional information.

Product Inspection

Upon receiving the HDMID-TPA from Wilder Technologies, perform the following product inspection:

- Inspect the outer shipping container, foam-lined instrument case, and product for damage. Retain the outer cardboard shipping container until the contents of the shipment have been inspected for completeness and the product has been checked mechanically and electrically. Use the foam-lined instrument-case for secure storage of the Wilder Technologies HDMI Test Adapter when not in use.
- Locate the shipping list and verify that all items ordered were received.
- In the unlikely event that the product is defective or incomplete, the “Limited Warranty” section discusses how to contact Wilder Technologies for technical assistance and/or how to package the product for return.

The HDMI Type-D HEAC Test Adapter Care and Handling Precautions

The HDMI Test Adapter requires careful handling to avoid damage. Improper handling techniques, or using too small a cable bend radius, can damage the coaxial cable connections within the adapter housing or the cables themselves. This can occur at any point along the cable. To achieve optimum performance and to prolong the HDMID-TPA's life, observe the following handling precautions:

- **CAUTION 1: Avoid Torque Forces (Twisting)**
While individual coaxial cables within the test adapter have some rotational freedom, twisting the HDMID-TPA as a unit, with one end held stationary, in excess of +/- 90° may damage or severely degrade performance. Adherence to Caution 5 (below) helps to avoid exceeding twist limits.
- **CAUTION 2: Avoid Sharp Cable Bends**
Never bend coaxial cables into a radius of 26 mm (1-inch) or less. Never bend cables greater than 90°. Single or multiple cable bends must be kept within this limit. Bending the HDMID-TPA cables less than a 26mm (1-Inch) radius will permanently damage or severely degrade test adapter performance.
- **CAUTION 3: Avoid Cable Tension (Pull Forces)**
Never apply tension (pull forces) to an individual coaxial cable that is greater than 2.3 kg (5 lbs.). To avoid applying tension, always place accessories and equipment on a surface that allows adjustment to eliminate tension on the HDMID-TPA and cables. Use adjustable elevation stands or apparatus to accurately place and support the HDMID-TPA.
- **CAUTION 4: Connect the HDMID-TPA First**
To prevent twisting, bending, or applying tension to the coaxial cables when connecting a HDMID-TPA, always attach the HDMID-TPA to the device under test (DUT) or cable under test before attaching any SMA connectors. Carefully align the HDMI Type-D connectors and then gently push the connectors together until fully seated.

If the HDMID-TPA must be turned or twisted to make connection to the DUT, avoid using the HDMID-TPA housing alone to make this occur. Try to distribute the torque forces along the length of the test setup and cabling. If this is not possible, it is recommended to first loosen or disconnect the SMA connections at the HDMID-TPA, make the connection to the DUT and then re-tighten or attach the test equipment leads.

NOTE: Only grip the test adapter housing when inserting or extracting the HDMID-TPA to or from the DUT. Pulling directly on the HDMID-TPA cables or using them to insert the HDMID-TPA may cause damage.

- **CAUTION 5: Carefully Make SMA Connections**

To connect the HDMID-TPA SMA connectors, follow these steps:

1. Hold the cable stationary by grasping the cable at the black heat-shrink section near the SMA connector.
2. Insert the mating SMA barrel and hand-tighten the free-spinning SMA nut onto the connector while avoiding pulling, bending, or twisting the HDMID-TPA coaxial cable.
3. The HDMID-TPA SMA connectors have flats that accept an open-end 1/4-inch or 6.5mm wrench. When attaching instrument cables to the HDMID-TPA, it is recommended that the HDMID-TPA SMA connectors be mechanically held and the test leads be tightened to the equipment manufacturer's torque recommendations, normally 5 in-lbs, using a 5/16-inch open-end wrench.

If the test set-up requires repositioning, first loosen or disconnect the SMA connections to avoid twisting, bending, or tension.

NOTE: A drop in signal amplitude by half or 6db during the testing of a lane may indicate that a cable has been mechanically pulled free of coaxial cable connections internal to the assembly. This could be determined by checking if the cable has any lateral play relative to the TPA. This would only occur when the TPA has exceeded the pull force as specified within the mechanical specification. If the cable cannot be re-seated, the test adapter will need to be sent back to the factory for service.

- **CAUTION 6: Independently Support Instrument Cables or Accessories**

Excessive weight from instrument cables and/or accessories connected to the HDMID-TPA can cause damage or affect the test adapter performance. Be sure to provide appropriate means to support and stabilize all test set-up components.

General Test Adapter, Cable, and Connector

Observing simple precautions can ensure accurate and reliable measurements.

Handling and Storage

Before each use of the HDMID-TPA, ensure that all connectors are clean. Handle all cables carefully and store the HDMID-TPA in the foam-lined instrument case when not in use, if possible. Do not set connectors contact end down. Install the SMA protective end caps when the HDMID-TPA is not in use.

Visual Inspection

Be sure to inspect all cables carefully before making a connection. Inspect all cables for metal particles, scratches, deformed threads, dents, or bent, broken, or misaligned center conductors. Do not use damaged cables.

Cleaning

If necessary, clean the connectors using low-pressure (less than 60 PSI) compressed air or nitrogen with an effective oil-vapor filter and condensation trap. Clean the cable threads, if necessary, using a lint-free swab or cleaning cloth moistened with isopropyl alcohol. Always completely dry a connector before use. Do not use abrasives to clean the connectors. Re-inspect connectors, making sure no particles or residue remains.

Making Connections

Before making any connections, review the “Care and Handling Precautions” section. Follow these guidelines when making connections:

- Align cables carefully
- Make preliminary connection lightly
- To tighten, turn connector nut only
- Do not apply bending force to cable
- Do not over-tighten preliminary connections
- Do not twist or screw-in cables
- Use a torque wrench, and do not tighten past the “break” point of the torque wrench

Electrostatic Discharge Information

Protection against electrostatic discharge (ESD) is essential while connecting, inspecting, or cleaning the HDMID-TPA test adapter and connectors attached to a static-sensitive circuit (such as those found in test sets).

Electrostatic discharge can damage or destroy electronic components. Be sure to perform all work on electronic assemblies at a static-safe work station, using two types of ESD protection:

- Conductive table-mat and wrist-strap combination
- Conductive floor-mat and heel-strap combination

When used together, both of these types provide a significant level of ESD protection. Used alone, the table-mat and wrist-strap combination provide adequate ESD protection. To ensure user safety, the static-safe accessories must provide at least 1 M Ω of isolation from ground. Acceptable ESD accessories may be purchased from a local supplier.

WARNING: These techniques for a static-safe work station should not be used when working on circuitry with a voltage potential greater than 500 volts.

User Model

The HDMI Type-D HEAC TPA supports testing with the HDMI CTS Version 1.4a. It is capable of performing well beyond the scope of measurements contained in the CTS, limited only by the specifications, environmental, care and handling as stated in this document.

The following examples are suggestions for possible testing setups.

In this first example, an HDMI Type-D HEAC plug TPA acts as a sink:

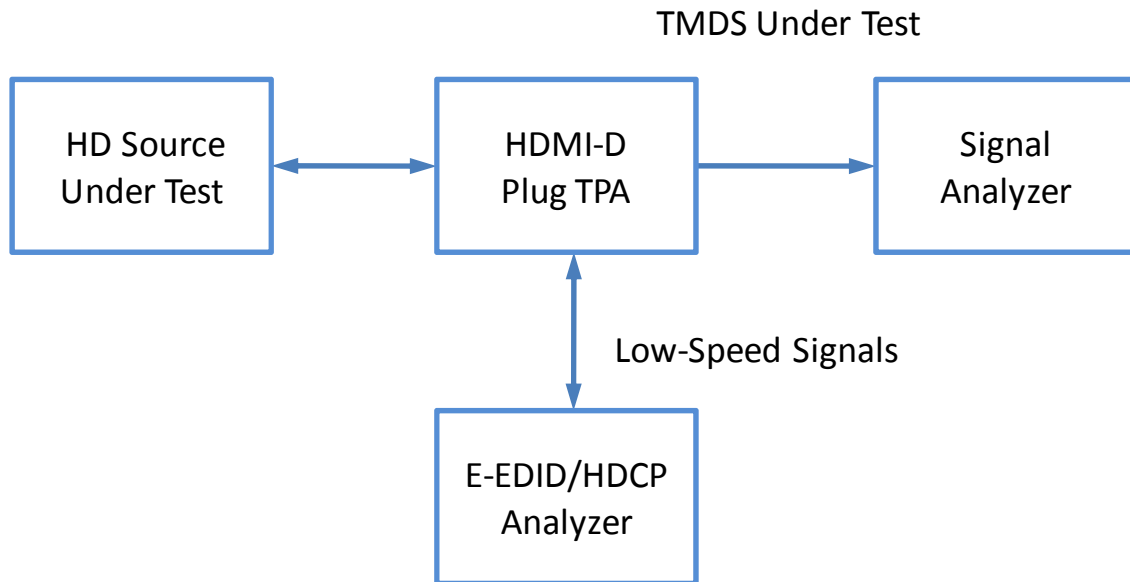

In the second example, the HDMI Type-D HEAC plug acts as a source:

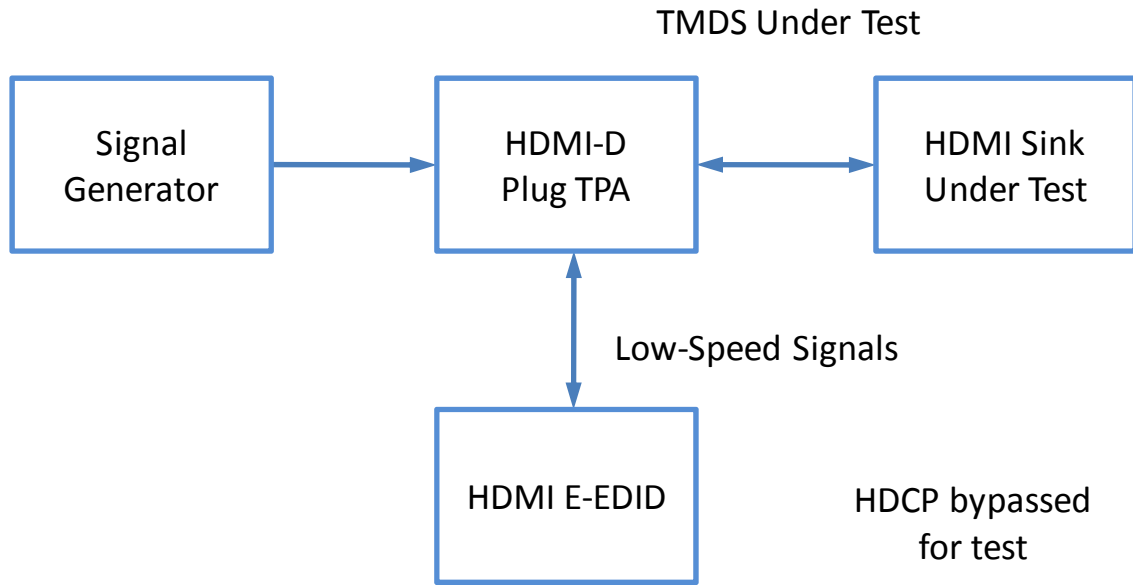

The third example shows two HDMI Type-D HEAC Receptacle TPAs acting as source and sink:

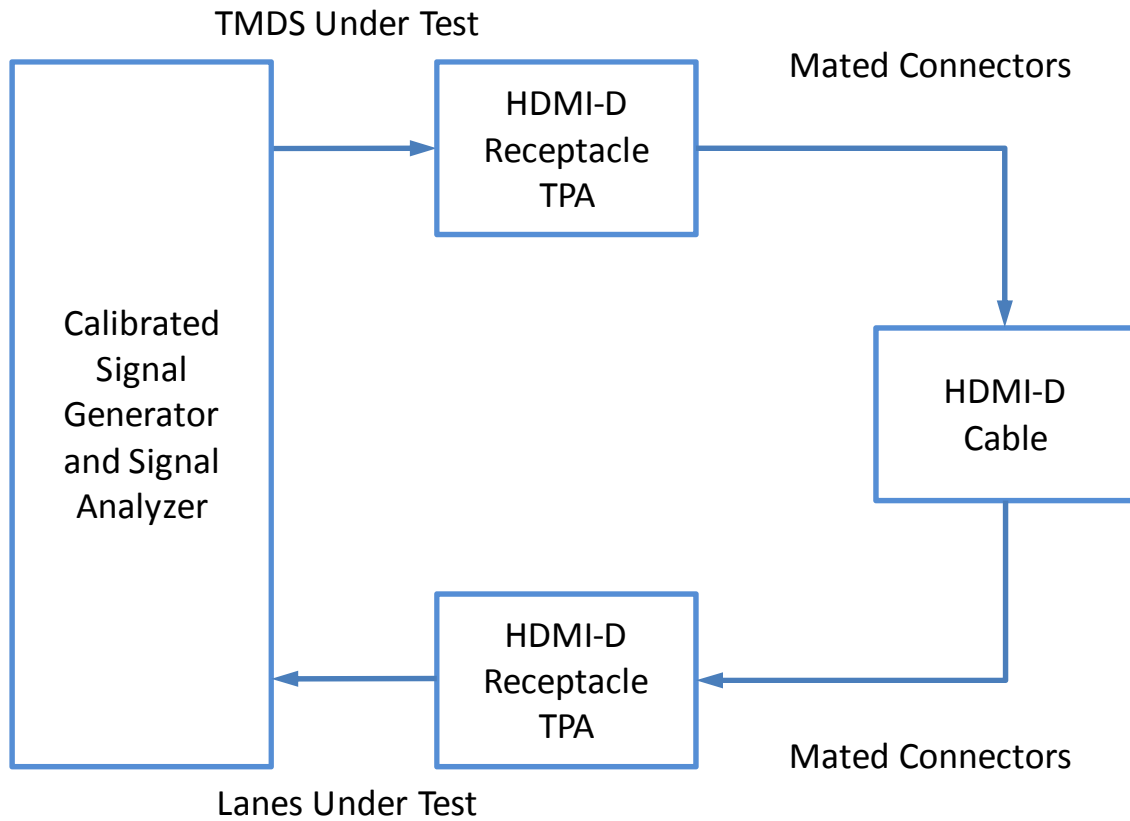

Calibration

The HDMI Plug and Receptacle Test Adapters are passive components. Therefore, calibration for the errors generated must occur within the test instrumentation that drives the sink or looks at the response of the source.

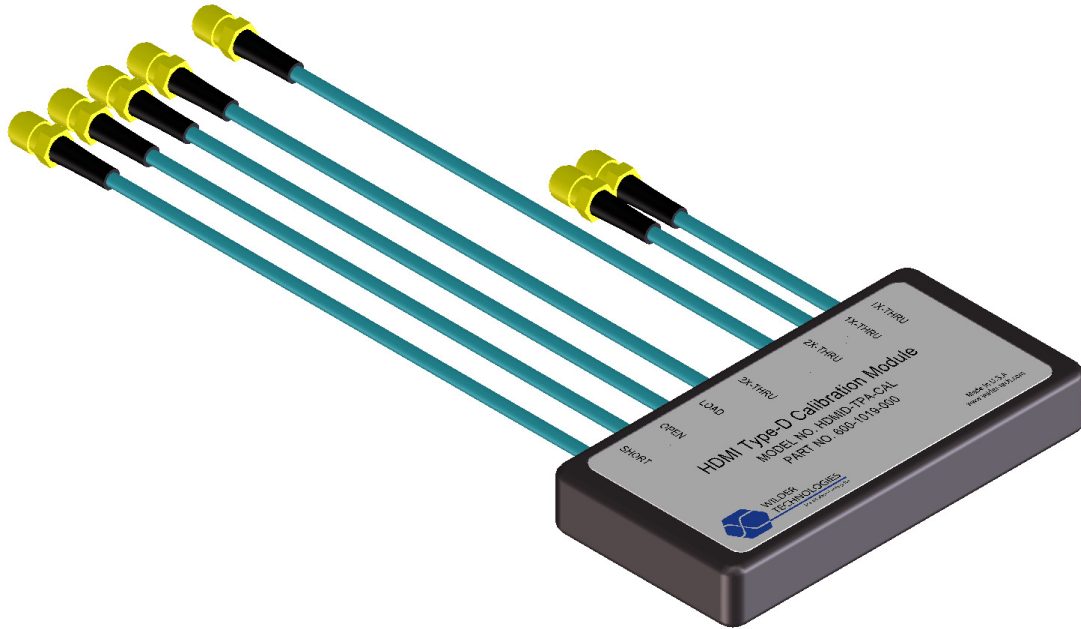

Figure 3. Calibration module (HDMID-TPA-C) showing standard 6-inch cable on SOLT and 3-inch cables connected to the 1X-THRU

SOLT

SHORT, OPEN, LOAD, and 2X-THRU (SOLT) are calibration standards used to compensate for errors associated with the TPA when used for Jitter measurement, TDR, TDT, and VNA testing. SOLT represents the same electrical length and losses as the TPA through the HDMI Type-D HEAC connector pad, and enables the test engineer to compensate for the following six repeatable, systematic errors that occur when moving the reference plane:

- Signal leakage effects: *Directivity errors*
- Signal leakage effects: *Crosstalk errors*
- Reflection effects: *Source Impedance Mismatching errors*
- Reflection effects: *Load Impedance Mismatching errors*
- Bandwidth effects: *Receiver Transmission in Test Equipment errors*
- Bandwidth effects: *Receiver Reflection-tracking in Test Equipment errors*

These errors need to be corrected on each port. Refer to the Instrument Manual for instructions on the instrument's specific calibration process.

NOTE: The reference plane is the boundary, both physically and electrically, between the calibrated and un-calibrated portions of the circuit. Everything outside the reference plane is considered part of the DUT. Any instrument that does not use calibration defines the DUT as the total of externally connected components. If the HDMID-TPA-C is not used, all of the HDMID-TPA and the 6-inch cables, as well as cables connecting the 6-inch cables to the test instrument, would be a part of the DUT.

Non-repeatable errors, such as drift or random errors, can be reduced but not corrected. Drift errors aggregate over time or with environmental changes such as temperature shift. To eliminate drift errors, perform another calibration.

A random error cannot be corrected through calibration since the error occurred randomly. Random errors are typically associated with either test instrument noise or test repeatability problems. Reduce test instrument noise by increasing source power, lowering the IF bandwidth, or averaging results over multiple sweeps. Reduce test repeatability problems through the use of a torque wrench or, again, by averaging over multiple sweeps.

1X-THRU

The 1X-THRU is a calibration feature used to calibrate time domain instrumentation (for example, pre-emphasized pulse generators or AWGs, arbitrary waveform generators). 1X-THRU calibration compensates two error sources – cable losses and group delay:

- **Cable Losses** – Cable losses associated with the HDMI Type-D HEAC plug TPA, and its respective cabling that's connected to the test source, consist of skin loss and, to a lesser extent, dielectric loss. Pre-emphasis or de-emphasis is used at the signal source to correct for these cable losses. Pre-emphasis is a boost of the signal level just after an edge transition; de-emphasis is a reduction in the low-speed amplitude of the signal source. Typically, on a de-emphasized signal the levels have to be reset to attain the same output levels. Resultant signals from either pre-emphasis or de-emphasis are identical relative to the DUT.

For the purposes of this discussion, pre-emphasis will be used. To set the pre-emphasis, first determine the amount of signal boost by connecting the signal source, via the 1X-THRU and the respective cable used to connect the DUT to the source to a high-speed oscilloscope or a jitter measurement device. Trigger the oscilloscope or jitter measurement device using a trigger from the source. The trigger, a single event, indicates the start of the signal being sent to the DUT. Adjust pre-emphasis to maximize the eye opening.

- **Group Delay** – Group delay is the second error source for 1X-THRU calibration. When the DUT generates an output signal, it can be used to measure delay. To create a baseline delay measurement, connect the output signal cable to the input signal cable and the 1X-THRU. To determine corrected DUT delay, subtract this baseline measurement from the DUT delay measurements.

E-EDID/Low Frequency Control Board

The E-EDID/Low Frequency Control Board (HDMID-TPA-E) is a tool that may be used to support testing HDMI cables and devices against the HDMI Compliance Test Specification (CTS) Version 1.4a.

The E-EDID/Low Frequency Control Board contains jumpers that easily configure the low-speed signal lines for several test conditions listed in the CTS. Test points are also provided for easy measurement access. Specific features and usage models are presented within Addendum A-1 of this document.

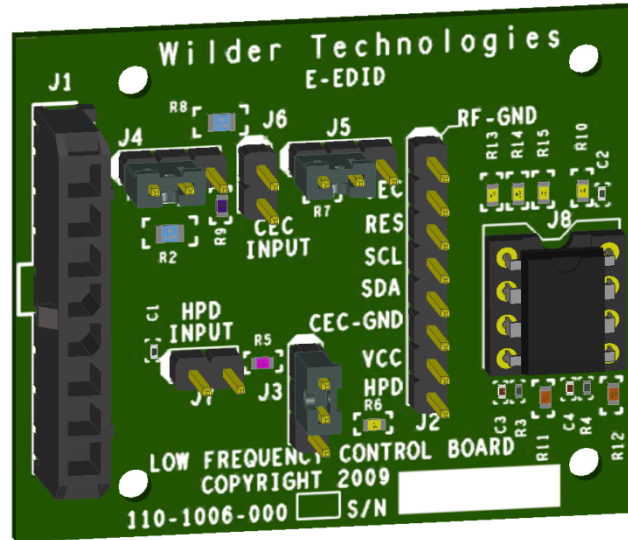

Figure 4. E-EDID/Low Frequency Control Board (HDMID-TPA-E)

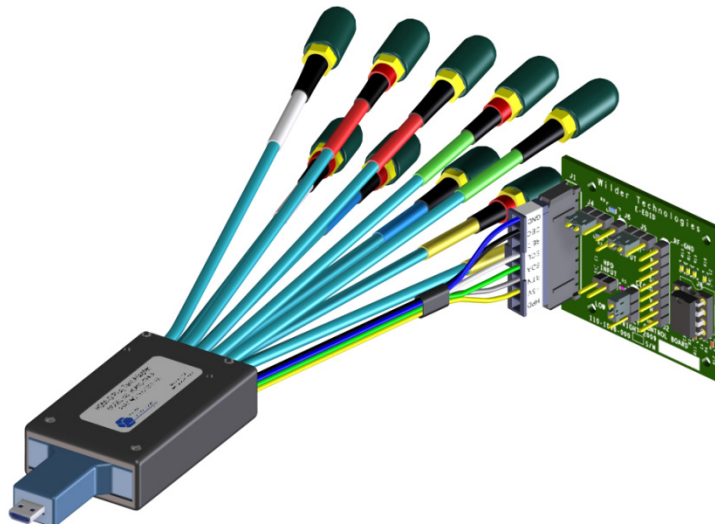

Figure 5. HDMID-TPA-E (E-EDID/Low Frequency Control Board) mated to a HDMID-TPA-P (Plug) Test Adapter

Mechanical and Environmental Specifications

NOTE: All specifications in this manual are subject to change.

Table 1. General Specifications

ITEM	DESCRIPTION
Usage Environment	Controlled indoor environment
Plug Test Adapter Length (w/std. cables)	189 mm +/- 2 mm (7.45 inches +/- .08 inches) (Characteristic)
Recpt. Test Adapter Length (w/std. cables)	182.5 mm +/- 2 mm (7.20 inches +/- .08 inches) (Characteristic)
Operating Temperature	0°C to +55°C (32°F to +131°F) (Characteristic)
Storage Temperature	-40°C to +70°C (-40°F to +158°F) (Characteristic)

HDMID-TPA Cable Pin-out

The HDMID-TPA cables provide ten SMA connectors (TMDS Data and Clock signals, and HEAC signals) and one low-speed connector. Labels clearly mark each cable or connector. The following figure refers to pin-description tables for each of the two connector types.

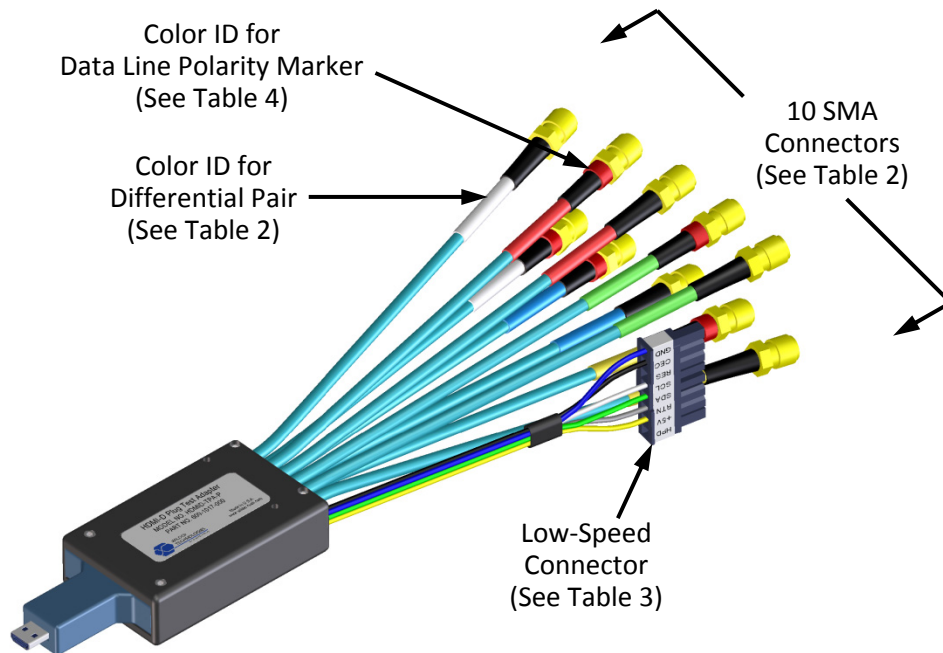

Figure 6. Cable Connectors (HDMID-TPA-P shown)

HDMI Type-D HEAC Test Adapter User Manual (Preliminary)

Table 2. SMA Cable Connectors (High-Speed)

LABEL	COLOR ID FOR DIFFERENTIAL PAIR	DESCRIPTION
D2+	Red	TMDS Data2+ for Source and Sink
D2-	Red	TMDS Data2- for Source and Sink
D1+	Blue	TMDS Data1+ for Source and Sink
D1-	Blue	TMDS Data1- for Source and Sink
D0+	Green	TMDS Data0+ for Source and Sink
D0-	Green	TMDS Data0- for Source and Sink
CLK+	Yellow	TMDS Clock+ for Source and Sink
CLK-	Yellow	TMDS Clock- for Source and Sink
UTIL/HEAC+	White	Utility for non-HEAC operation, or HEAC+ for Source and Sink
HPD/HEAC-	White	Hot Plug Detect for non-HEAC operation, or HEAC- for Source and Sink

Table 3. HDMI-D-TPA Eight-Position Cable Connector “P2” (Low-Speed)

LABEL	PIN NO.	COLOR ID FOR TPA-P (PLUG)	COLOR ID FOR TPA-R (RECEPTACLE)	DESCRIPTION
GND	Pin 1	Blue	Blue	RF Ground
CEC	Pin 2	Black	Black	Consumer Electronics Control
RES	Pin 3	Not Used	Not Used	No connect
SCL	Pin 4	White	White	I ² C Clock for DDC
SDA	Pin 5	Green	Green	I ² C Data for DDC
RTN	Pin 6	Gray	Gray	DDC/CEC Ground
+5V	Pin 7	Yellow	Yellow	+5V Power
HPD	Pin 8	Not Used	Not Used	No connect

HDMI Type-D HEAC Test Adapter User Manual (Preliminary)

Table 4. HDMI Type-D HEAC Plug and Receptacle Pin Assignments

Pin Description	Connector Pin Number	Destination Number (Source/Sink)	Color ID for Data Line Polarity	Color Identification (Plug/Receptacle)
HPD/HEAC-	1	HPD/HEAC-	Black	White Label
Utility/HEAC+	2	UTIL/HEAC+	Red	White Label
TMDS Data2+	3	D2+	Red	Red Label
Ground	4	Ground	N/A	N/A
TMDS Data2-	5	D2-	Black	Red Label
TMDS Data1+	6	D1+	Red	Blue Label
Ground	7	Ground	N/A	N/A
TMDS Data1-	8	D1-	Black	Blue Label
TMDS Data0+	9	D0+	Red	Green Label
Ground	10	Ground	N/A	N/A
TMDS Data0-	11	D0-	Black	Green Label
TMDS Clock+	12	CLK+	Red	Yellow Label
Ground	13	Ground	N/A	N/A
TMDS Clock-	14	CLK-	Black	Yellow Label
CEC	15	P2 Pin 2	N/A	Black Insulation
DDC/CEC Ground	16	P2 Pin 6	N/A	Gray Insulation
SCL	17	P2 Pin 4	N/A	White Insulation
SDA	18	P2 Pin 5	N/A	Green Insulation
+5V POWER	19	P2 Pin 7	N/A	Yellow Insulation
Ground	4, 7, 10, 13	P2 Pin 1	N/A	Blue Insulation

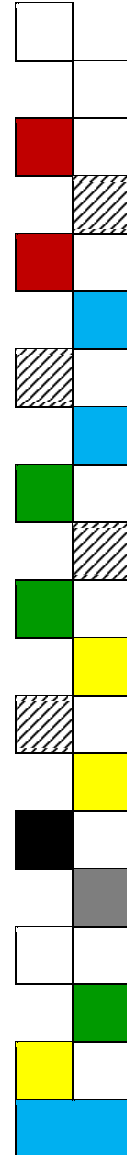

Electrical Specifications

NOTE: All specifications in this manual are subject to change.

Table 5. Electrical Specifications

SPECIFICATION	MINIMUM	TYPICAL	MAXIMUM	NOTES
Insertion Loss (GHz), at -3 db	10	12		2X-THRU with six-inch cables
Return Loss (GHz), at -20 db	10	12		2X-THRU with six-inch cables
Insertion Loss (GHz), at -3 db		25		1X-THRU with three-inch cables
Return Loss (GHz), at -20 db		7.8		1X-THRU with three-inch cables
VSWR, at 10 GHz	1.21:1			2X-THRU with six-inch cables
Differential Impedance (ohms), at 100 ps Rise Time	95		105	All TMDS data and clock, Receptacle and Plug, excluding HDMI connector
Differential Impedance (ohms), at 200 ps Rise Time	90		110	All TMDS data and clock, Receptacle and Plug, including HDMI connector
Impedance (ohms) , 100 ps Rise Time	47.5		52.5	All TMDS data and clock, Receptacle and Plug, excluding HDMI connector
Impedance (ohms) , 100 ps Rise Time	47.5		52.5	SHORT, OPEN, LOAD, 1X-THRU, and 2X-THRU
Intra-lane Skew (ps)	-6		6	All TMDS data and clock, Receptacle and Plug
Inter-lane Skew (ps)	-6		6	All TMDS data and clock, Receptacle and Plug
NEXT (db), at 9 GHz, at 6.75 GHz at 4.05 GHz	-40	-45 -45		All TMDS data and clock, single aggressor, without HDMI connector, with six-inch cables and terminations
Differential Impedance (ohms), at 100 ps Rise Time	95		105	HEAC, Receptacle and Plug, excluding HDMI connector
Differential Impedance (ohms), at 200 ps Rise Time	90		130	HEAC, Receptacle and Plug, including HDMI connector
Current Carrying (A)	0.5			+5V Power and DDC/CEC Grounds

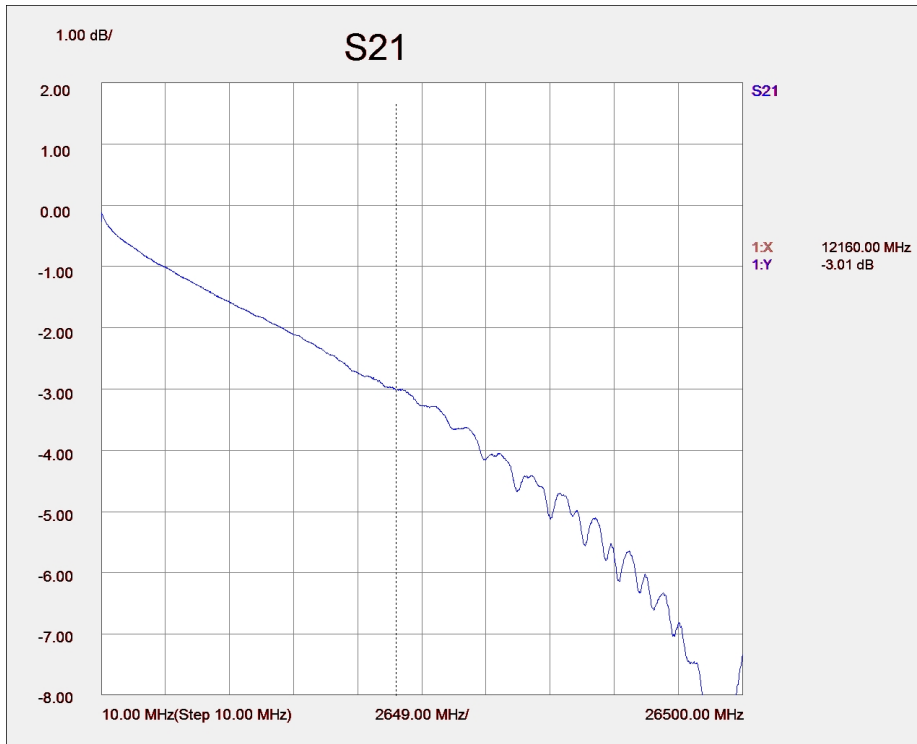

Figure 7. Typical 2X-THRU insertion loss

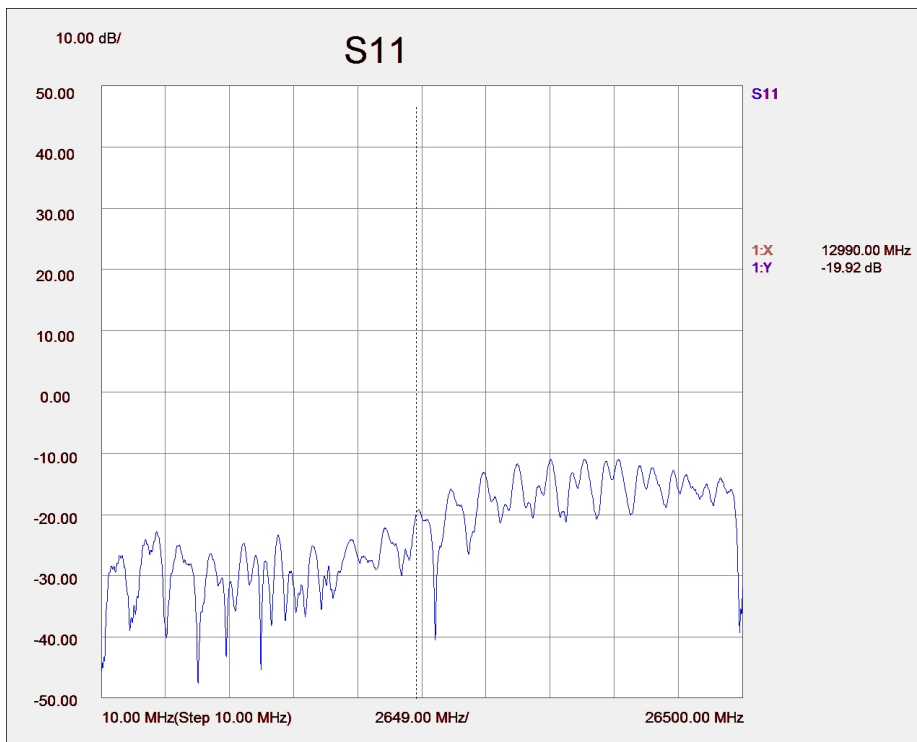

Figure 8. Typical 2X-THRU return loss

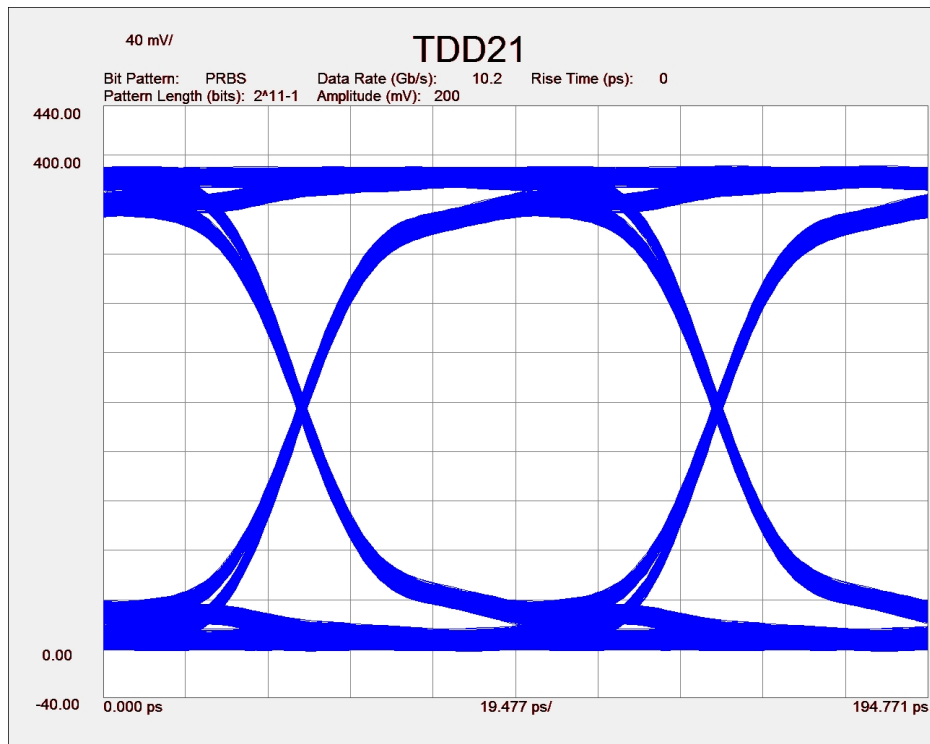
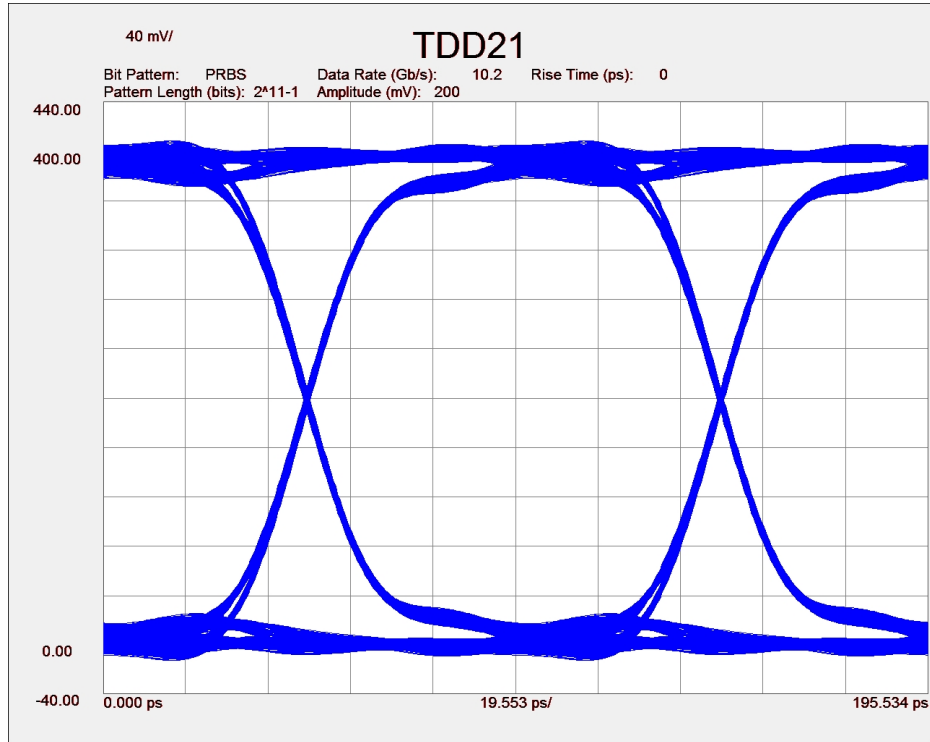

Figure 9. Typical TMDS mated pair 10.2 Gb/s eye diagram, with calibration (top) and without calibration (bottom)

Parameter Measurement Result

Name	Measurement Result
Eye Level Zero(mV)	6.44
Eye Level One(mV)	391.81
Eye Level Mean(mV)	199.12
Eye Amplitude(mV)	385.36
Eye Height(mV)	354.39
Eye Height(db)	-4.51
Eye Width	9.56e-011
Eye Opening Factor	0.92
Eye Signal_to_Noise	25.43
Eye Duty Cycle Dist	-4.17e-014
Eye Duty Cycle Dist(%)	-0.04
Eye Rise Time (20-80)	2.04e-011
Eye Fall Time (80-20)	2.04e-011
Eye Jitter(PP)	2.39e-012
Eye Jitter(RMS)	4.33e-013

S_n Param DUT Files Meas

Parameter Measurement Result

Name	Measurement Result
Eye Level Zero(mV)	6.25
Eye Level One(mV)	389.97
Eye Level Mean(mV)	198.11
Eye Amplitude(mV)	383.72
Eye Height(mV)	345.42
Eye Height(db)	-4.62
Eye Width	9.56e-011
Eye Opening Factor	0.90
Eye Signal_to_Noise	22.72
Eye Duty Cycle Dist	-1.68e-015
Eye Duty Cycle Dist(%)	-0.00
Eye Rise Time (20-80)	2.11e-011
Eye Fall Time (80-20)	2.11e-011
Eye Jitter(PP)	2.39e-012
Eye Jitter(RMS)	4.03e-013

S_n Param DUT Files Meas

Figure 10. Typical TMDS mated pair 10.2 Gb/s eye measurements, with calibration (top) and without calibration (bottom)

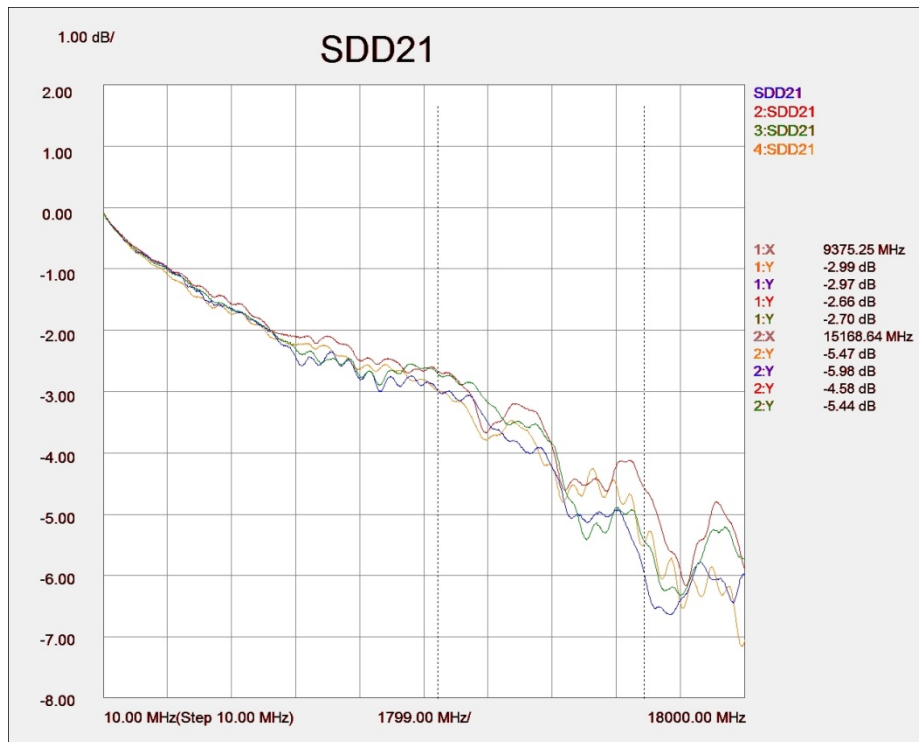
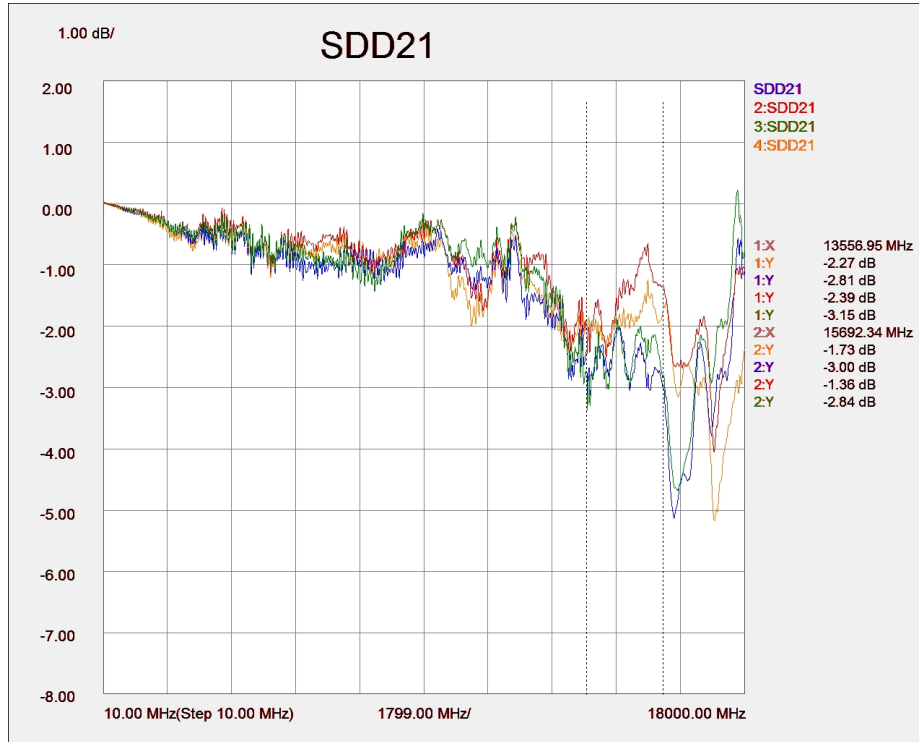

Figure 11. Typical TMSD mated pair balanced insertion loss, with calibration (top) and without calibration (bottom)

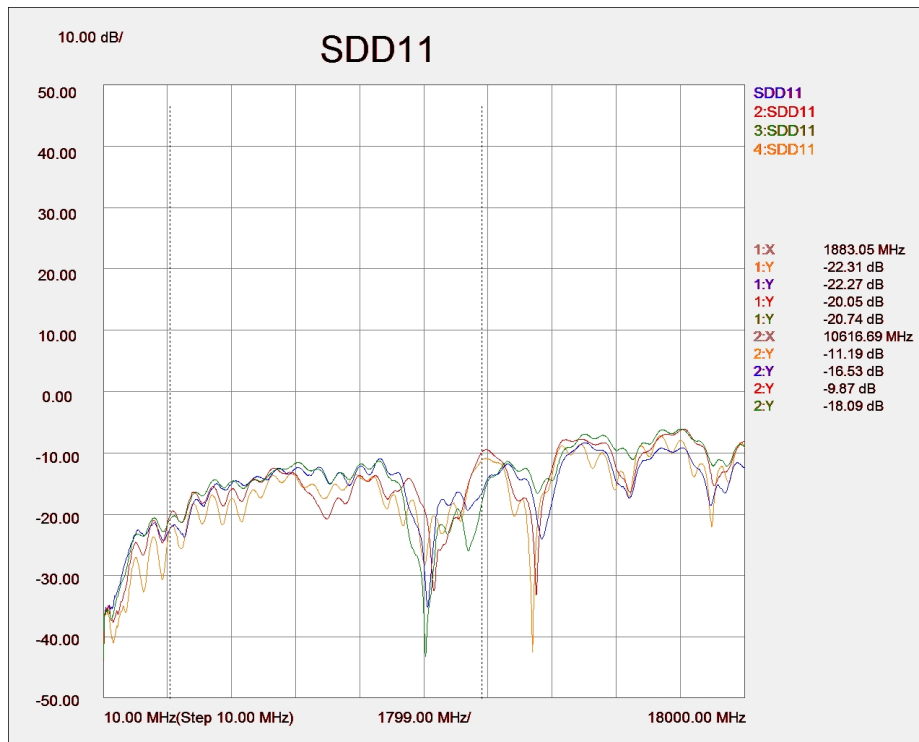
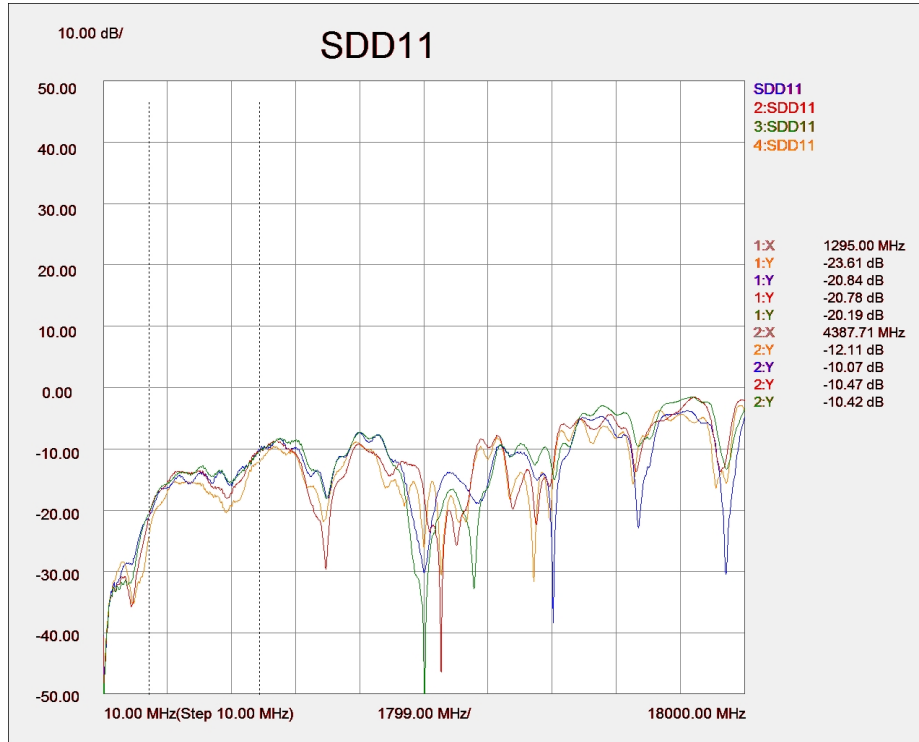

Figure 12. Typical TMSD mated pair balanced return loss, with calibration (top) and without calibration (bottom)

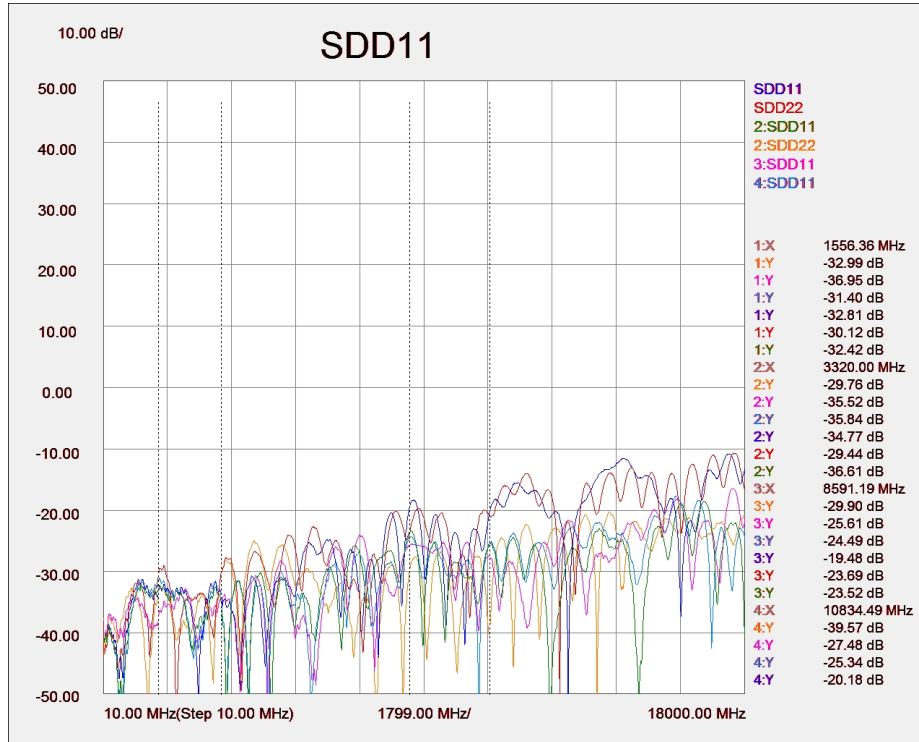

Figure 13. Typical TMS on TPA balanced return loss, differential termination replacing connector

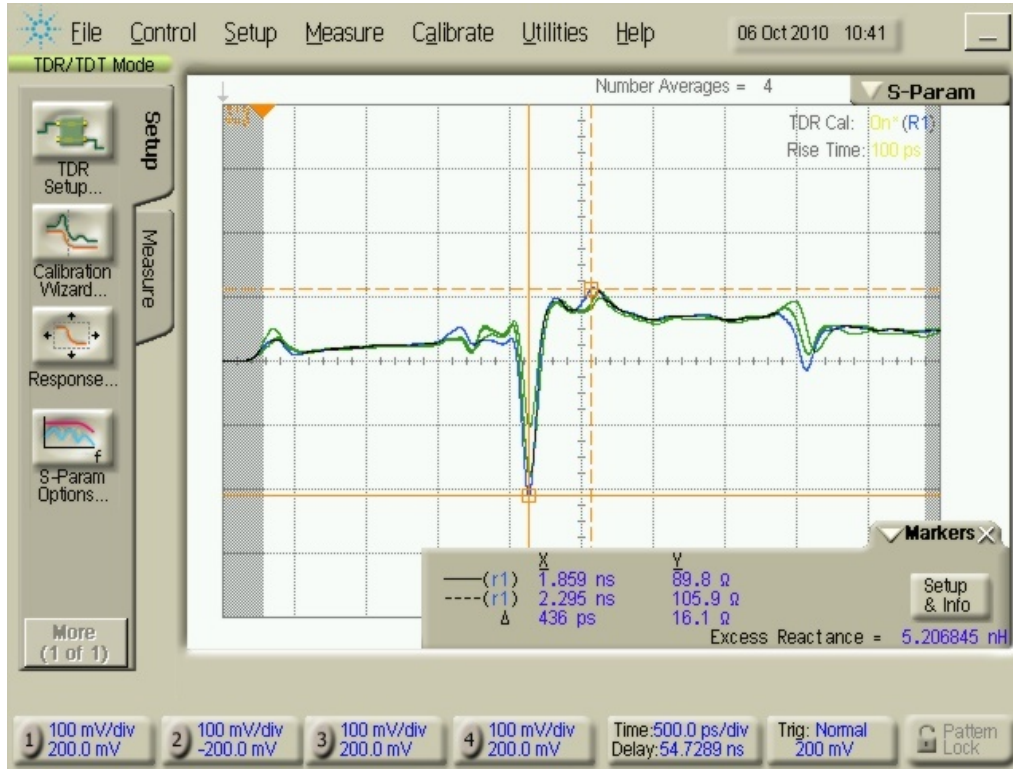

Figure 14. Typical differential TDR of TMDS, HDMI-D-TPA-P connected to HDMI-D-TPA-R at 100 ps Rise Time

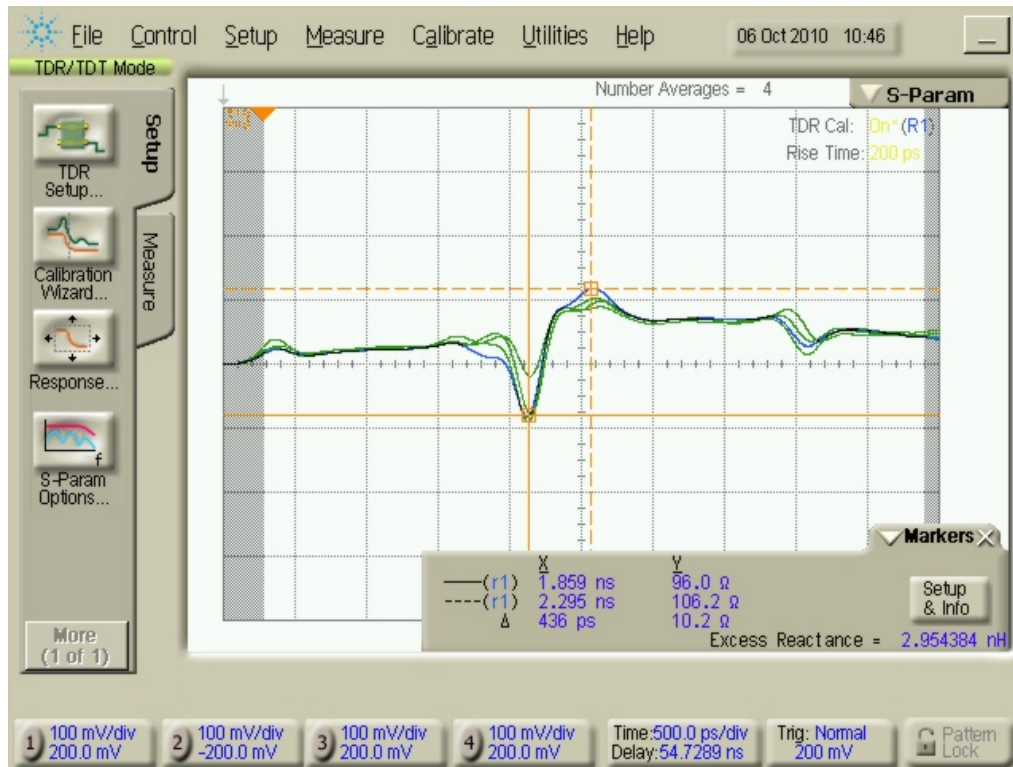

Figure 15. Typical differential TDR of TMDS, HDMI-D-TPA-P connected to HDMI-D-TPA-R at 200 ps Rise Time

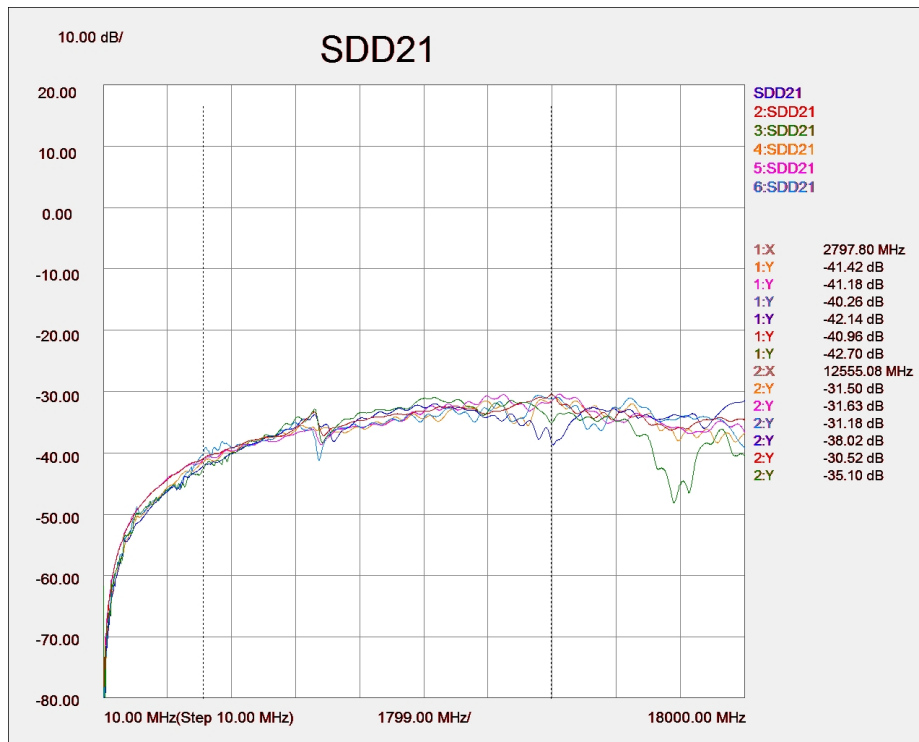
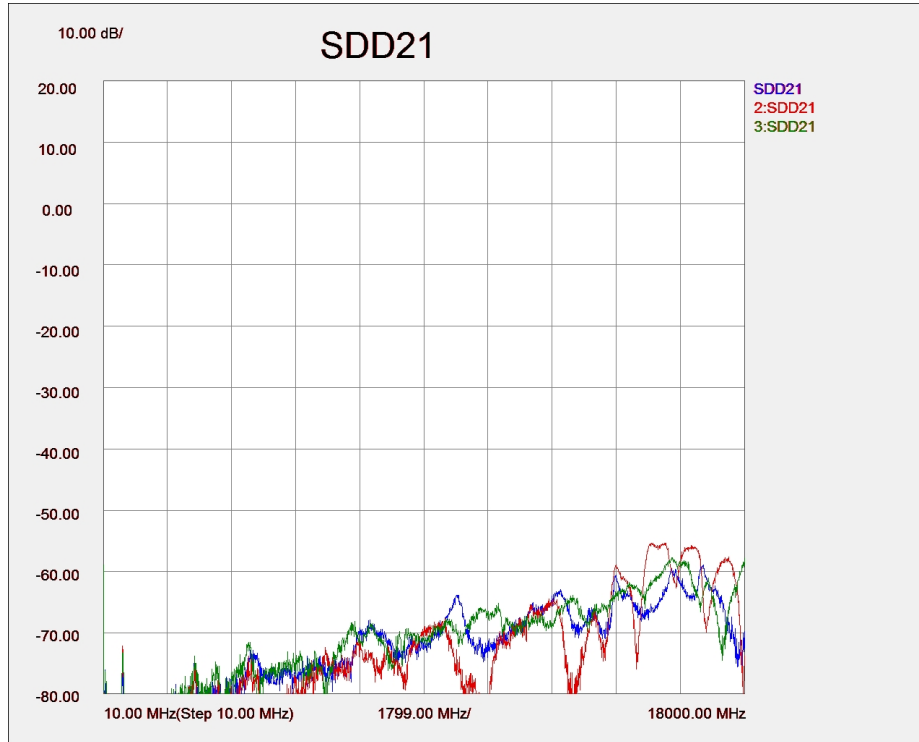

Figure 16. Typical Differential NEXT of TMDs, without connector (top) and with mated connectors (bottom), adjacent lanes, all lanes terminated at both ends

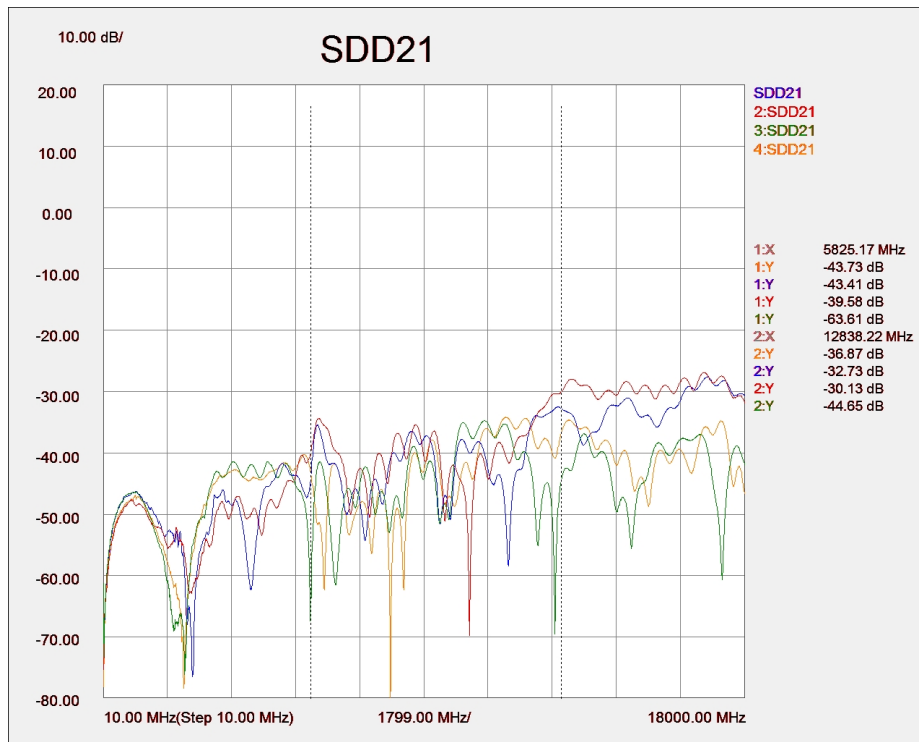
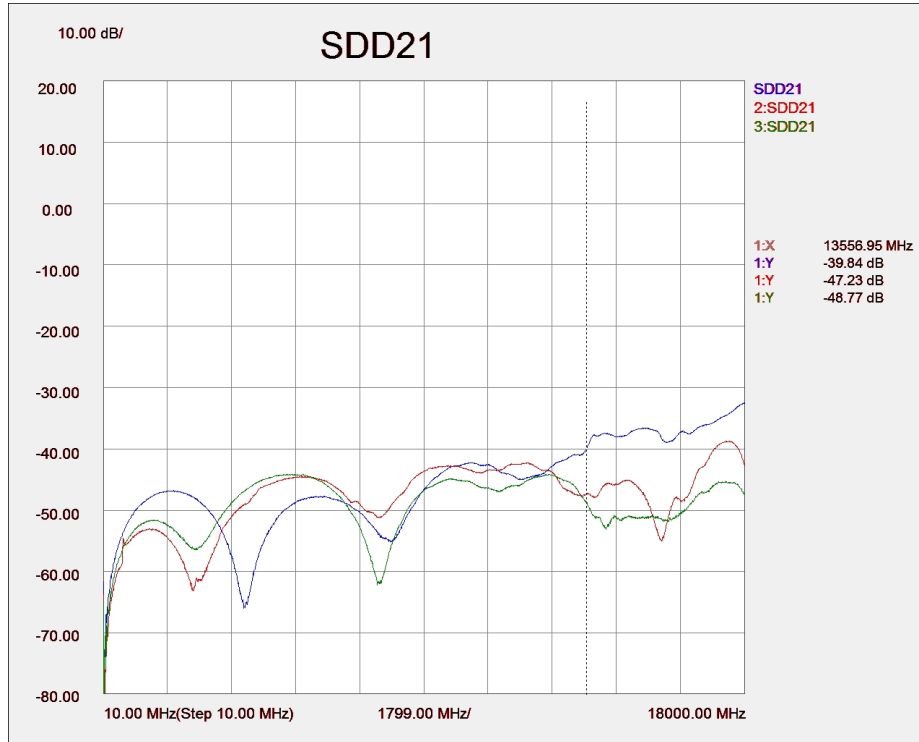

Figure 17. Typical Differential NEXT of TMDs, without connector (top) and with mated connectors (bottom); skipped lanes, even to even or odd to odd; all lanes terminated at both ends

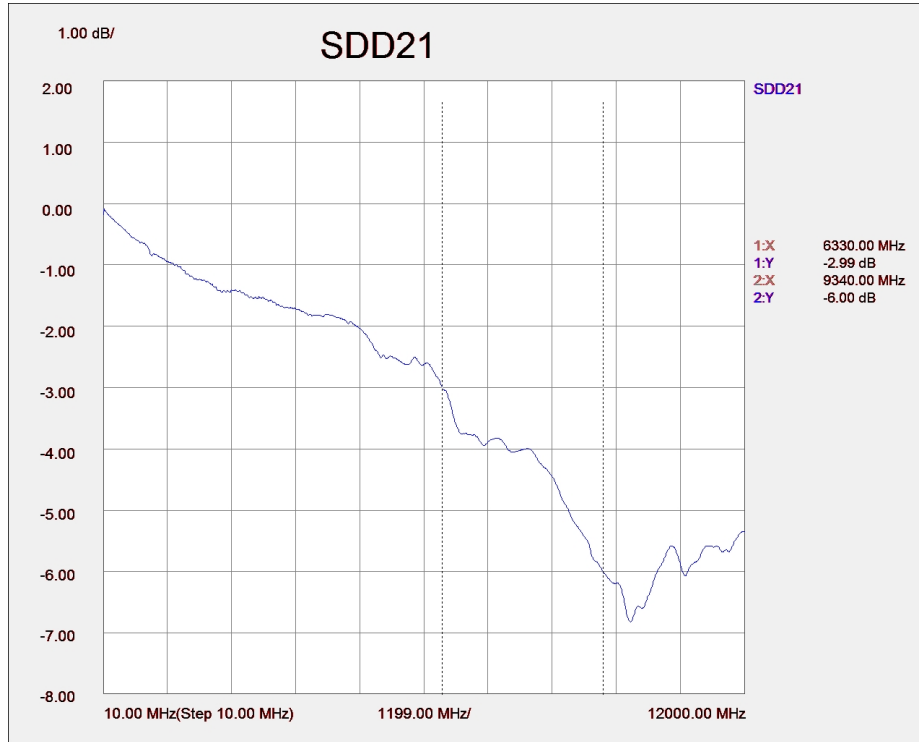

Figure 18. Typical HEAC mated pair balanced insertion loss.

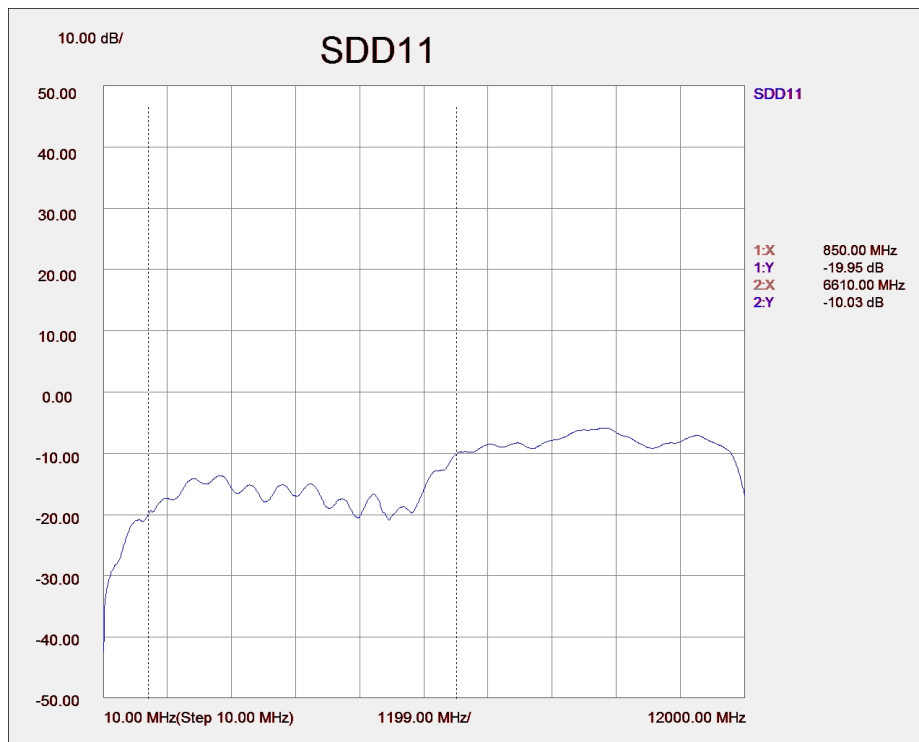

Figure 19. Typical HEAC mated pair balanced return loss.

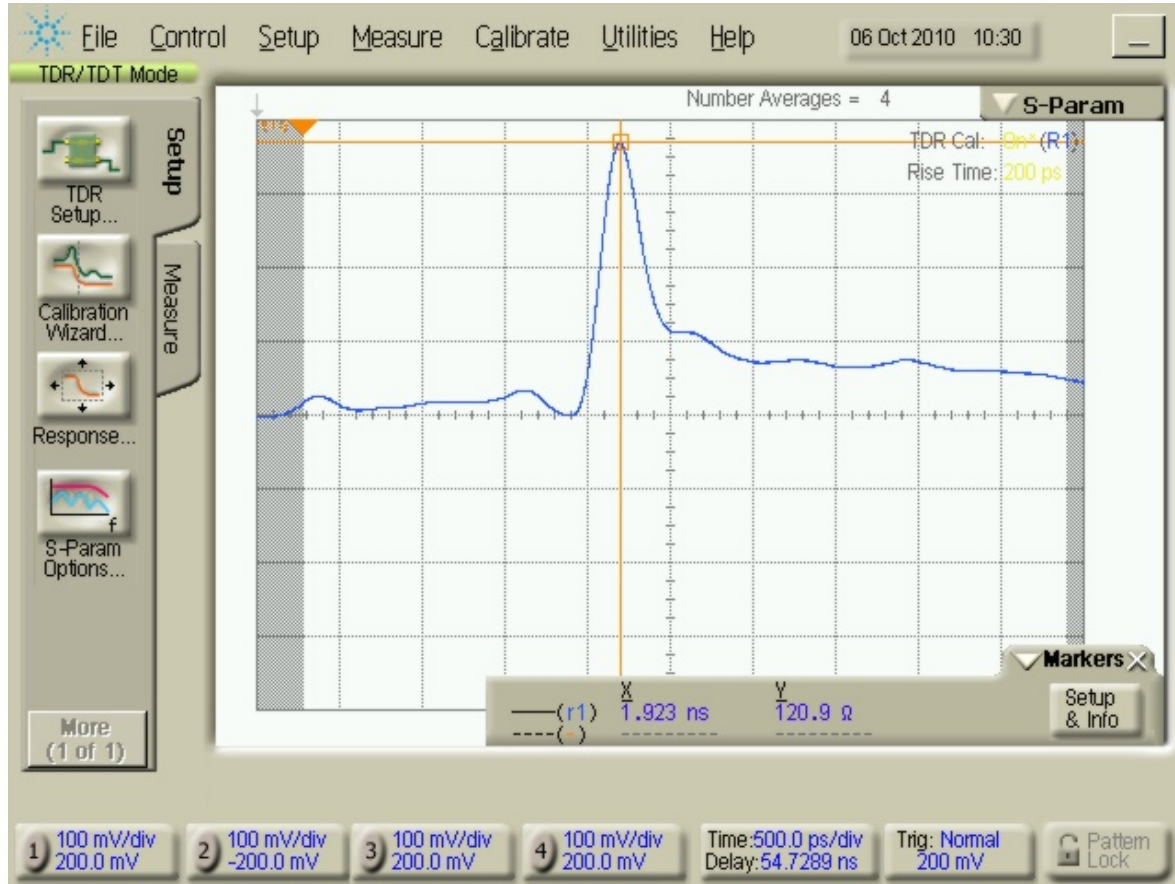

Figure 20. Typical differential TDR of HEAC, HDMID-TPA-P connected to HDMID-TPA-R at 200 ps Rise Time

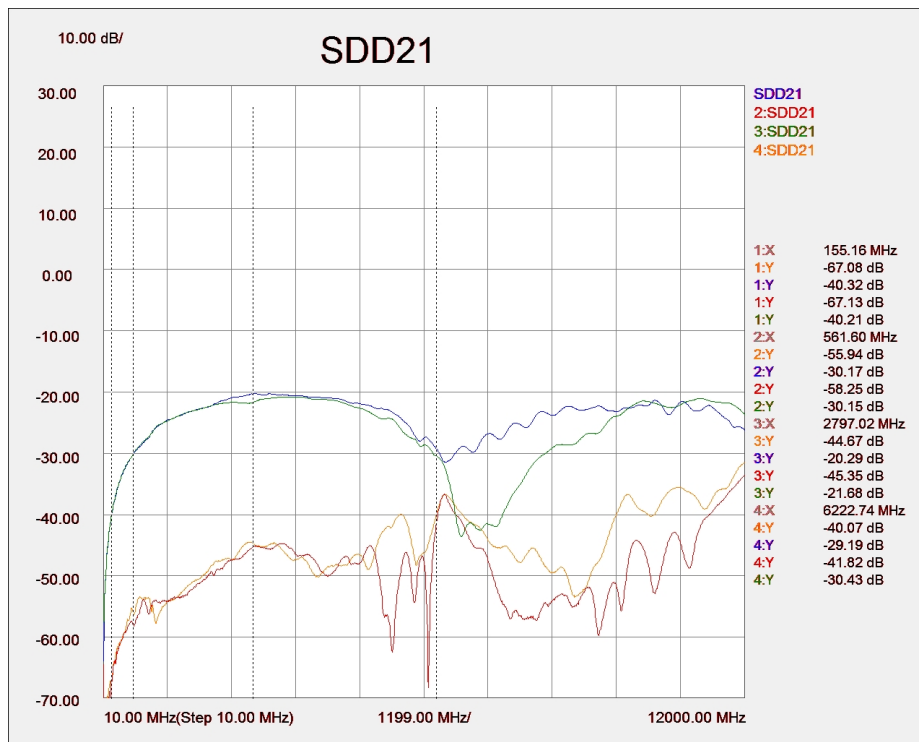
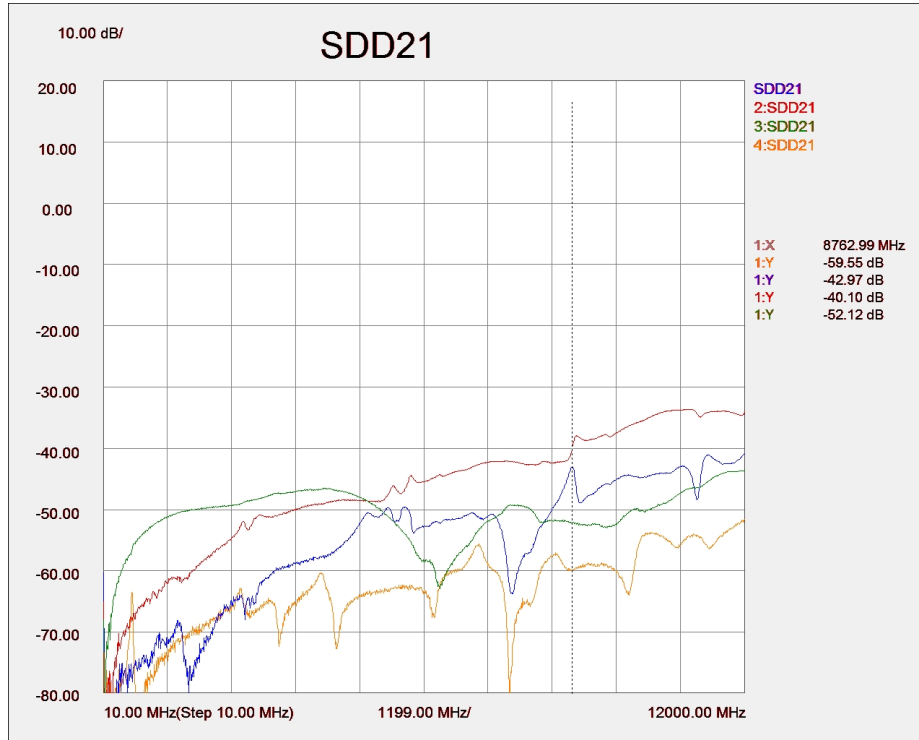

Figure 21. Typical Differential NEXT of HEAC to D2, without connector (top) and with mated connectors (bottom); all lanes terminated at both ends

NOTE: The HDMI-D primary connector has the HEAC- pin adjacent to the TMDS2+ pin and therefore generates the above crosstalk in the mated connector plot.

Wilder Technologies, LLC – Limited Warranty

Wilder Technologies, LLC warrants that each Test Adapter, 1) is free from defects in materials and workmanship and, 2) conforms to Wilder Technologies specifications for a period of 12 months. **See Consumable and Fragile Material Warranty for exceptions to the 12 month warranty**

The warranty period for a Test Adapter is a specified, fixed period commencing on the date of ship from Wilder Technologies, LLC. If you did not purchase your Test Adapter directly from Wilder Technologies, LLC, the serial number and a valid proof of purchase will be required to establish your purchase date. If you do not have a valid proof of purchase, the warranty period will be measured from the date of ship from Wilder Technologies, LLC.

If, during the warranty period, the Test Adapter is not in good working order, Wilder Technologies, LLC will, at its option, repair or replace it at no additional charge, except as is set forth below. In some cases, the replacement Test Adapter may not be new and may have been previously installed. Regardless of the Test Adapter's production status, Wilder Technologies, LLC appropriate warranty terms apply.

Consumable and Fragile Material Warranty

Wilder Technologies, LLC warrants that consumable materials and all fragile materials supplied by Wilder Technologies, LLC either as part of an instrument or system, or supplied separately, will be free from defects in material and workmanship at the time of shipment.

Extent of Warranty

The warranty does not cover the repair or exchange of a Test Adapter resulting from misuse, accident, modification, unsuitable physical or operating environment, improper maintenance by you, or failure caused by a product for which Wilder Technologies, LLC is not responsible. The warranty is voided by removal or alteration of Test Adapter or parts identification labels. The initial three months are unconditional; the remaining months excludes plugs, receptacles and SMA connectors. Connectors are wear items and excluded from the warranty after the initial three months.

These warranties are your exclusive warranties and replace all other warranties or conditions, express or implied, including but not limited to, the implied warranties or conditions or merchantability and fitness for a particular purpose. These warranties give you specific legal rights and you may also have other rights which vary from jurisdiction to jurisdiction. Some jurisdictions do not allow the exclusion or limitation of express or implied warranties, so the above exclusion or limitation may not apply to you. In that event, such warranties are limited in duration to the warranty period. No warranties apply after that period.

Items Not Covered by Warranty

Wilder Technologies, LLC does not warrant uninterrupted or error-free operation of a Test Adapter.

Any technical or other support provided for a Test Adapter under warranty, such as assistance via telephone with "how-to" questions and those regarding Test Adapter set-up and installation, will be provided **WITHOUT WARRANTIES OF ANY KIND**.

Warranty Service

Warranty service may be obtained from Wilder Technologies, LLC by returning a Wilder Technologies, LLC Returns Material Authorization and the Test Adapter to Wilder Technologies, LLC during the warranty period. To obtain RMA number, contact support@wilder-tech.com.

You may be required to present proof of purchase or other similar proof of warranty entitlement. You are responsible for any associated transportation charges, duties and insurance between you and Wilder Technologies, LLC. In all instances, you must ship Test Adapters in Wilder Technologies, LLC approved packaging. Information on packaging guidelines can be found at: www.wilder-tech.com. Wilder Technologies, LLC will ship repaired or replacement Test Adapter Delivery Duty Prepaid (DDP) and will pay for return shipment. You will receive title to the repaired or replacement Test Adapter and you will be the importer of record.

Wilder Technologies, LLC – Terms & Conditions of Sale

- 1. Other Documents:** This Agreement may NOT be altered, supplemented, or amended by the use of any other document(s) unless otherwise agreed to in a written agreement signed by both you and Wilder Technologies, LLC. If you do not receive an invoice or acknowledgement in the mail, via e-mail, or with your Product, information about your purchase may be obtained at support@wilder-tech.com or by contacting your sales representative.
- 2. Payment Terms, Orders, Quotes, Interest:** Terms of payment are within Wilder Technologies, LLC's sole discretion, and unless otherwise agreed to by Wilder Technologies, LLC, payment must be received by Wilder Technologies, LLC prior to Wilder Technologies, LLC's acceptance of an order. Payment for the products will be made by credit card, wire transfer, or some other prearranged payment method unless credit terms have been agreed to by Wilder Technologies, LLC. Invoices are due and payable within the time period noted on your invoice, measured from the date of the invoice. Wilder Technologies, LLC may invoice parts of an order separately. Your order is subject to cancellation by Wilder Technologies, LLC, in Wilder Technologies, LLC's sole discretion. Unless you and Wilder Technologies, LLC have agreed to a different discount, Wilder Technologies, LLC's standard pricing policy for Wilder Technologies, LLC-branded systems, which includes hardware, software and services in one discounted price, allocates the discount off list price applicable to the service portion of the system to be equal to the overall calculated percentage discount off list price on the entire system. Wilder Technologies, LLC is not responsible for pricing, typographical, or other errors in any offer by Wilder Technologies, LLC and reserves the right to cancel any orders resulting from such errors.
- 3. Shipping Charges; Taxes; Title; Risk of Loss:** Shipping, handling, duties and tariffs are additional unless otherwise expressly indicated at the time of sale. Title to products passes from Wilder Technologies, LLC to Customer on shipment from Wilder Technologies, LLC's facility. Loss or damage that occurs during shipping by a carrier selected by Wilder Technologies, LLC is Wilder Technologies, LLC's responsibility. Loss or damage that occurs during shipping by a carrier selected by you is your responsibility. You must notify Wilder Technologies, LLC within 7 days of the date of your invoice or acknowledgement if you believe any part of your purchase is missing, wrong or damaged. Unless you provide Wilder Technologies, LLC with a valid and correct tax exemption certificate applicable to your purchase of Product and the Product ship-to location, you are responsible for sales and other taxes associated with the order. **Shipping dates are estimates only.**
- 4. WARRANTY:** WILDER TECHNOLOGIES, LLC, warrants that the item(s) manufactured under the Buyer's contract shall be free from defects in materials and workmanship furnished by WILDER TECHNOLOGIES, LLC, and shall conform to the applicable drawings and specifications. WILDER TECHNOLOGIES, LLC'S liability herein, for breach of warranty, contract or negligence in manufacturing, shall be limited to repair or replacement. Repair or replacement of defective items will be applicable only if the Buyer notifies WILDER TECHNOLOGIES, LLC, by written notice within 30-days of delivery. All claims shall be addressed to: support@wilder-tech.com or WILDER TECHNOLOGIES, LLC, 6101A East 18th Street, Vancouver, Washington 98661 U.S.A.; ATTENTION: Customer Service Manager. WILDER TECHNOLOGIES, LLC, reserves the right to inspect at the Buyer's plant all items claimed to be defective or nonconforming prior to authorizing their return. WILDER TECHNOLOGIES, LLC, assumes no liability for the results of the use of its components in conjunction with other electric, electronic or mechanical components, circuits and/or systems. The foregoing constitutes the sole and exclusive remedy of the Buyer and the exclusive liability of WILDER TECHNOLOGIES, LLC, and is IN LIEU OF ANY AND ALL OTHER WARRANTIES, STATUTORY, IMPLIED OR EXPRESSED AS TO MERCHANTABILITY, FITNESS FOR THE PURPOSE SOLD, DESCRIPTION, QUALITY, and PRODUCTIVENESS OR ANY OTHER MATTER. Without limiting the foregoing, in no event shall WILDER TECHNOLOGIES, LLC, be liable for loss of use, profit or other collateral, or for special and/or consequential damages.
- 5. RETURNED GOODS:** WILDER TECHNOLOGIES, LLC, will accept only those goods for return that have been authorized for return. All goods authorized for return shall be assigned a Returned Material Authorization (RMA) Number. The RMA Number shall be clearly marked on the shipping container(s) and all documentation accompanying the goods authorized for return. The RMA Number shall be assigned by WILDER TECHNOLOGIES, LLC pursuant to the conditions set forth in Paragraph 4, WARRANTY.
- 6. UNITED STATES GOVERNMENT CONTRACTS:** In the event this offer is accepted under Government contract, WILDER TECHNOLOGIES, LLC, agrees to accept clauses required by Government regulations and to waive WILDER TECHNOLOGIES, LLC conditions inconsistent therewith. WILDER TECHNOLOGIES, LLC, certifies that it is a regular manufacturer or dealer of the goods and/or services offered herein and that the prices offered do not exceed those charged to any customer for like quantities, services or materials under the same conditions.

Compliance with Environmental Legislation

Wilder Technologies, LLC, is dedicated to complying with the requirements of all applicable environmental legislation and regulations, including appropriate recycling and/or disposal of our products.



WEEE Compliance Statement

The European Union adopted Directive 2002/96/EC on Waste Electrical and Electronic Equipment (WEEE), with requirements that went into effect August 13, 2005. WEEE is intended to reduce the disposal of waste from electrical and electronic equipment by establishing guidelines for prevention, reuse, recycling and recovery.

Wilder Technologies has practices and processes in place to conform to the requirements in this important Directive.

In support of our environmental goals, effective January 1st, 2009 Wilder Technologies, LLC has partnered with E-Tech Recycling of Beaverton, Oregon, www.etechnology.com, to recycle our obsolete and electronic waste in accordance with the European Union Directive 2002/96/EC on waste electrical and electronic equipment ("WEEE Directive").

As a service to our customers, Wilder Technologies is also available for managing the proper recycling and/or disposal of all Wilder Technologies products that have reached the end of their useful life. For further information and return instructions, contact support@wilder-tech.com.

Glossary of Terms

TERMINOLOGY	DEFINITION
Aggressor	A signal imposed on a system (i.e., cable assembly) to measure response on other signal carriers.
Box-to-box connection	HDMI Type-D link between two boxes detachable by an end user. An HDMI Type-D cable-connector assembly for the box-to-box connection shall have three TMDS Link lanes.
CEC	Consumer Electronics Control
DDC	Display Data Channel (VESA)
HDMI Type-D Receiver	Circuitry that receives the incoming HDMI Type-D TMDS Link data. Located in Sink Device and the upstream port of Intermediate Device.
HDMI Type-D Transmitter	Circuitry that transmits the HDMI Type-D TMDS Link data located in Source Device and in the downstream port of Intermediate Device.
HDMID-TPA-H	HDMI Type-D HEAC Test Point Access. A specialized assembly that interfaces to a HDMI Type-D HEAC receptacle or plug and enables access of signals for measurement or stimulation including the HEAC signals.
Dual-standard Device Source or Sink	Device that supports both DisplayPort and DVI/HDMI operating modes.
Informative	The designation of a test that is not required for compliance but is considered important from a characterization standpoint. It is provided for informational purposes only.
Normative	The designation of a test that is required for compliance.
Sink Device	A device that contains A/V stream sinks for display and/or sound.
Source Device	A device that contains a stream source and originates an isochronous A/V stream.
TMDS	Transition Minimized Differential Signaling
Victim	A signal carrier on a system that has a response imposed on it by other signals in the system.

E-EDID Addendum A-1

This addendum provides documentation of E-EDID/Low Frequency Control Board (HDMID-TPA-E) as to its content and operation. It also contains documentation of the provided EE-PROM which may or may not be used in the course of the testing.

E-EDID/Low Frequency Control Board reference information

This section contains an illustration of the E-EDID/Low Frequency Control Board, the schematic, primary cable attachment detail, secondary cable attachment for probing and/or HDCP signal injection, and specification of the E-EDID/Low Frequency Control Board.

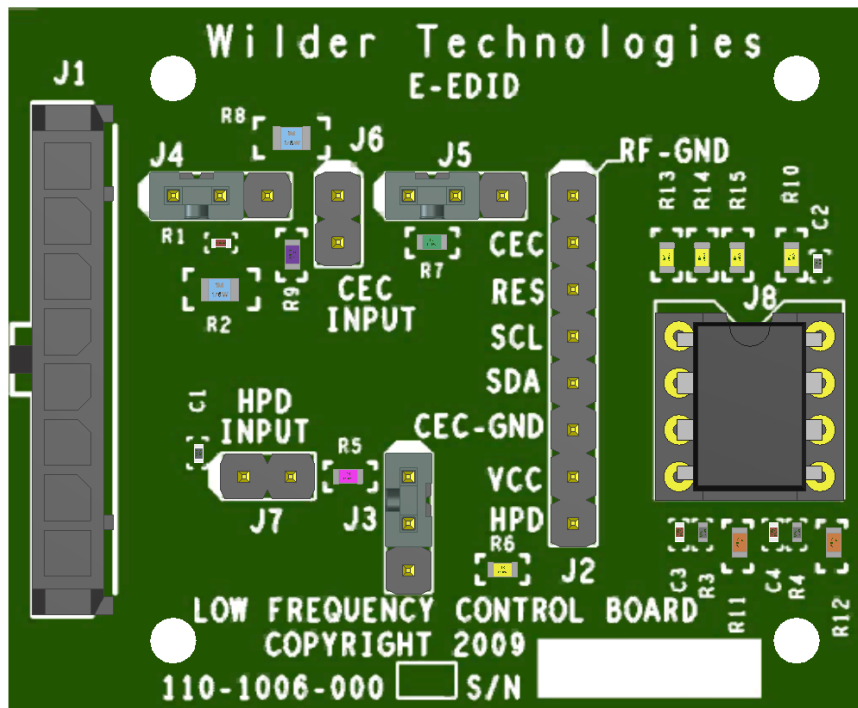

Figure A-1. E-EDID/Low Frequency Control Board

The previous figure shows the E-EDID/Low Frequency Control Board.

- J1 is the primary attachment point for the low speed signals from the HDMID-TPA.
- J2 is the secondary attachment point for probing or for injecting HDCP signals.
- J3 is the HPD grounding connection.
- J4 is CEC switching connection.
- J5 is CEC grounding connection.
- J6 is the Power and return input for CEC.
- J7 is the Power and return input for HPD.
- J8 is the socket for the E-EDID EE-PROM.

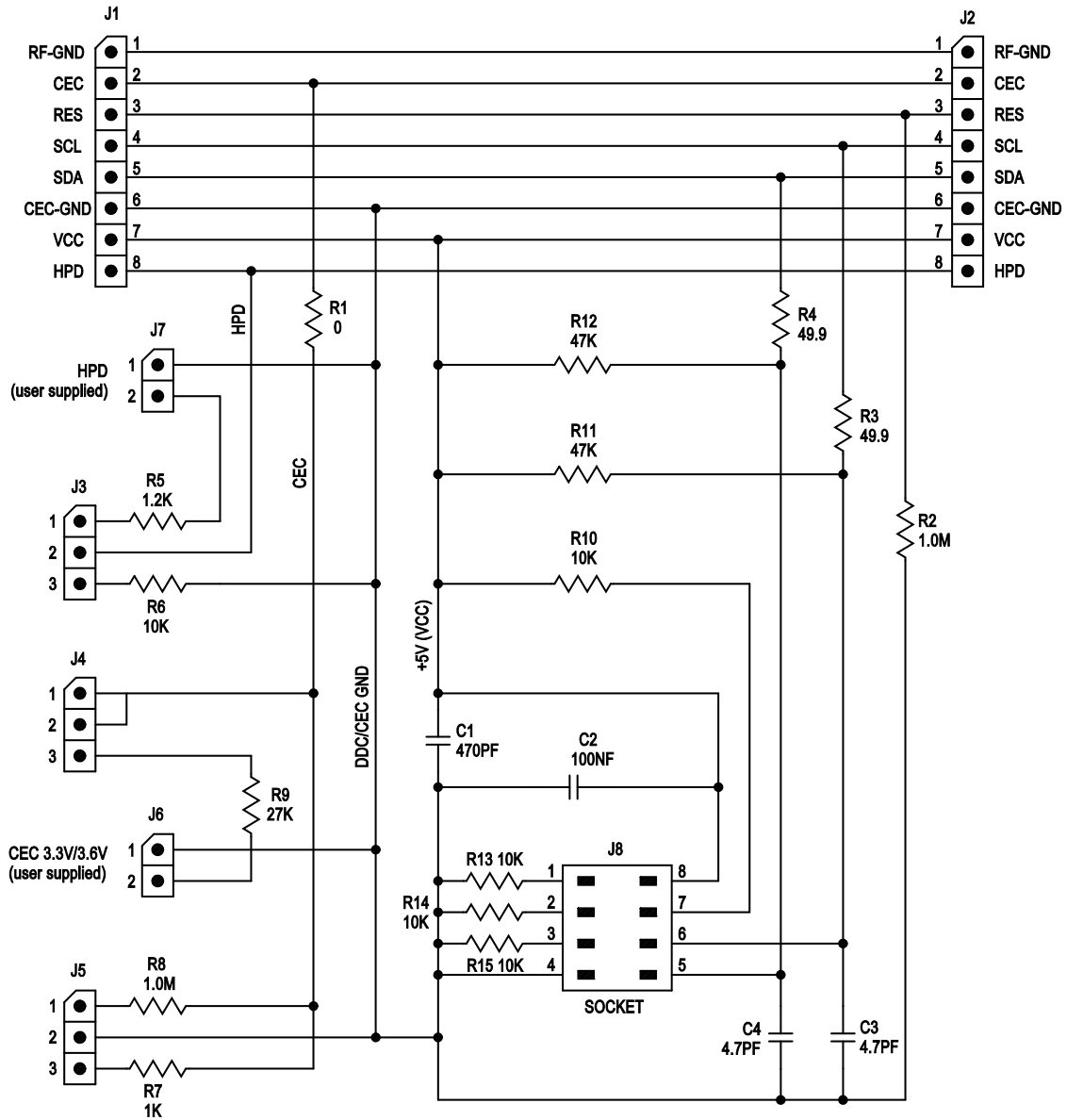

Figure A-2. E-EDID/Low Frequency Control Board Schematic

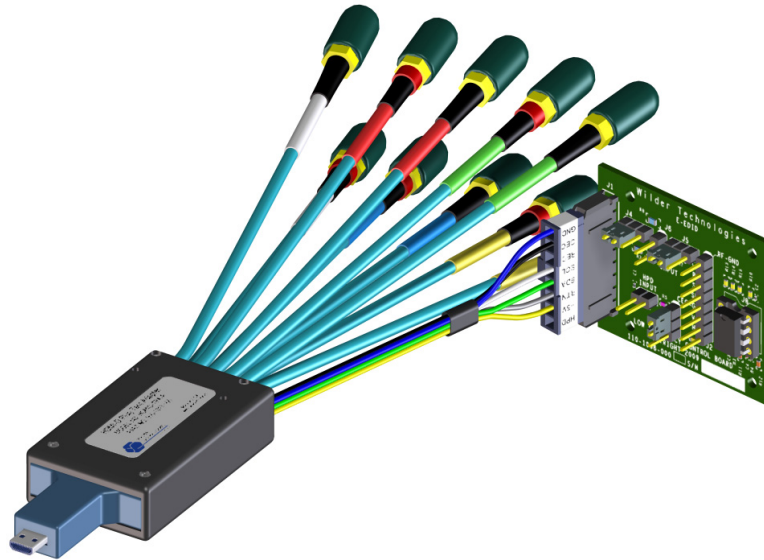

Figure A-3. E-EDID/Low Frequency Control Board attached to a HDMID-TPA Plug

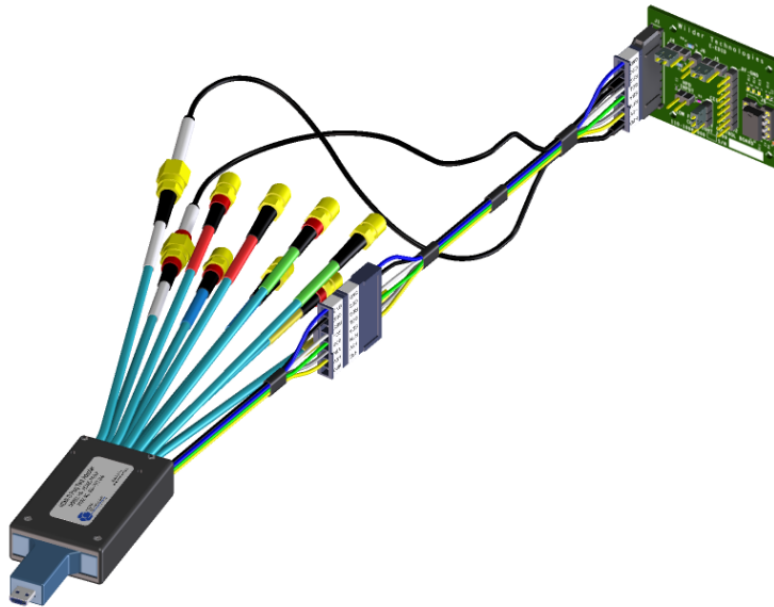

Figure A-4. E-EDID/Low Frequency Control Board utilizing the HEAC adapter cable assembly between the HDMID-TPA Plug and the EDID/Low Frequency Board for non-HEAC testing

Table A-1. E-EDID/Low Frequency Control Board Electrical Specifications

SPECIFICATION	MINIMUM	TYPICAL	MAXIMUM	NOTES
Vcc (V)	2.5	5.0	5.5	Required by EE-PROM
Icc (mA)			5.3	With EE-PROM, SDA = SDC = 0V
HPD current (mA), Vhpd = 3.3V			3.1	
CEC current (μA), Vcec = 3.3V			136	

E-EDID/Low Frequency Control Board User Model

This section documents using an external power supply for HPD and CEC, the use of the HPD and CEC circuitry for testing, and source testing of the E-EDID per the CTS. Most tests require interaction with the E-EDID to setup the HDMI protocol to the necessary state for testing.

NOTE: The E-EDID/Low Frequency Control Board does not provide for testing HDCP functionality. An external data generator must be used to test this functionality.

The following are examples of tests that are from the CTS. They are included to explain the operation of the E-EDID/Low Frequency Control Board. They are not meant to replace the most recent version of the CTS. Please follow the requirements of the most recent version for the CTS.

Within the HDMI Compliance Test Specification Version 1.4a, HPD testing is performed as follows:

- For Cable testing, the HPD test is TEST ID 5-12: HPD Detect signal. Two E-EDID/Low Frequency Control Boards can be used to connect Power on the Source side connector and to measure HPD at the Sink connector. No EEPROM is required for this test.
- For Source testing TEST ID 7-12: Hot Plug Detect.
- For Sink testing TEST ID 8-10: HPD Output Voltage and TEST ID 8-11: HPD Output Resistance.

NOTE: The HPD tests as indicated are non-HEAC tests. For HEAC connected testing, the external data generator needs to fulfill the HPD tests or revert to a non-HEAC test configuration.

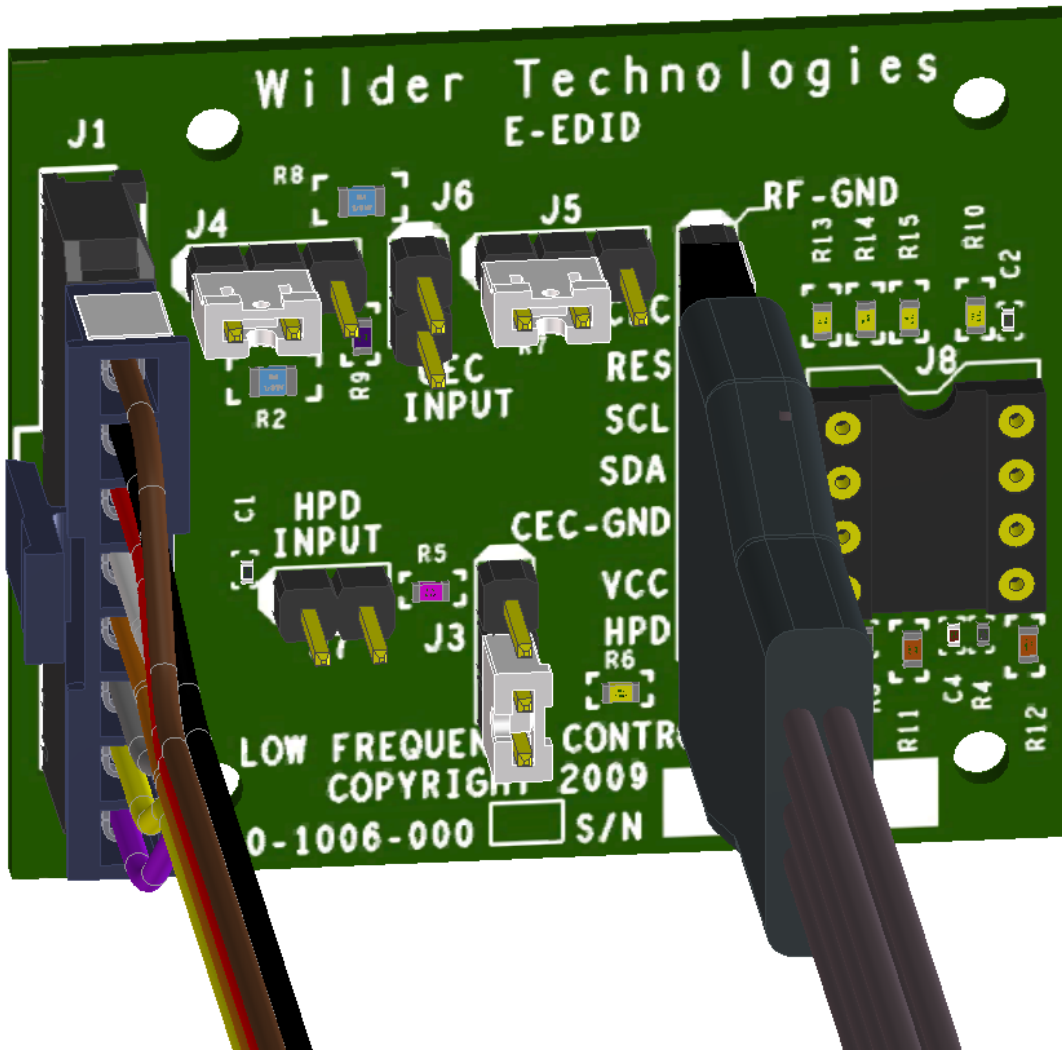

Figure A-5. E-EDID/Low Frequency Control Board connected for sink testing

Note that jumper J3 is connecting pins 2 to 3, this is the sink testing position for HPD. Also note that power is connected between VCC and CEC GND of the secondary connector. Exercise caution in setting the correct polarity of this power supply. In addition, the secondary connector, J2, signal SCL is used to clock out the DDC data on SDA.

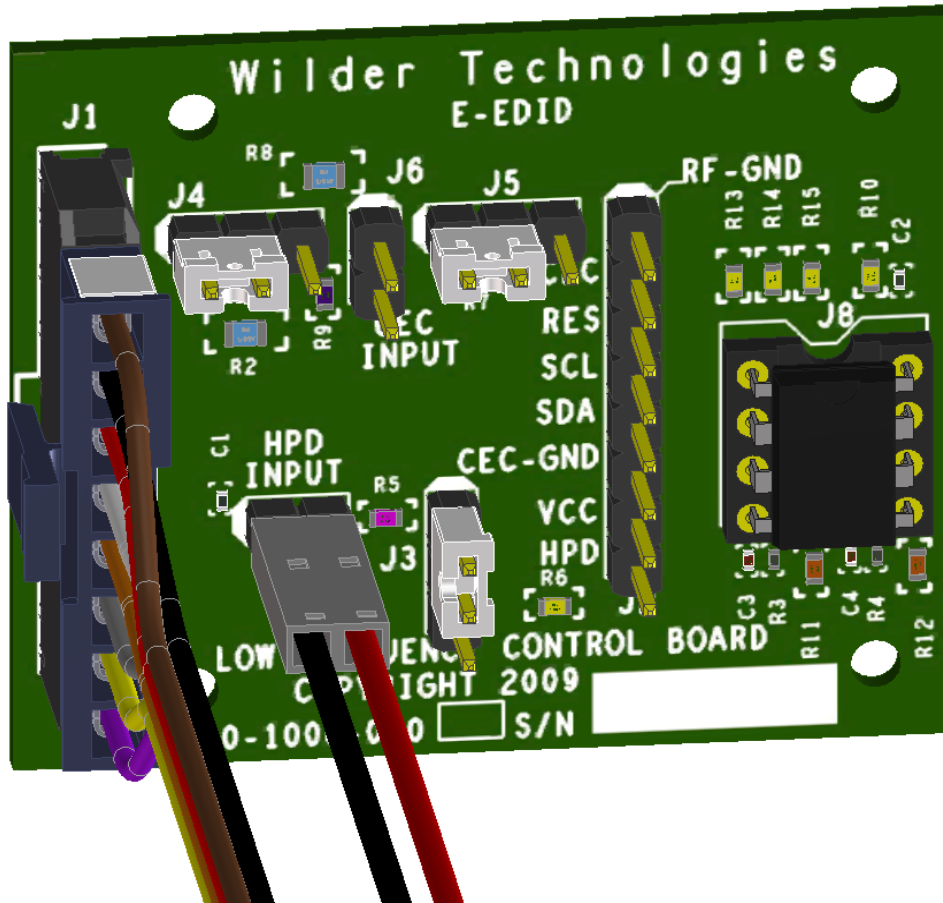

Figure A-6. E-EDID/Low Frequency Control Board connected for source testing

Note that jumper J3 is connecting pin 1 to 2, this is the source testing position for HPD. Also note that HPD power is connected to J7. Exercise caution in setting the correct polarity of this power supply. J7-1 is DDC/CEC ground and J7-2 is the HPD power source. The power supply connected to HPD input is adjusted during the course of the testing.

The E-EDID/Low Frequency Control Board has been designed to include the functionality of the TPA-CEC-R -- Quiescent CEC Electrical Test Fixture.

Within the HDMI Compliance Test Specification Version 1.4a, CEC testing is performed as follows:

- For Cable testing, TEST ID 5-14: CEC communication.
- For Source testing TEST ID 7-15: CEC Line degradation. CEC voltage measurements are taken with 1 Meg Ohm load to CEC GND, with 3.3V through 27k Ohms, with 1k Ohm load to CEC GND, with the divider created between the 3.3V 27k Ohms and the 1k Ohm to CEC GND. And then the current is measured with 3.63V through the 27k Ohms.
- For Sink testing TEST ID 8-14: CEC Line Degradation. CEC voltage measurements are taken with 1 Meg Ohm load to CEC GND, with 3.3V through 27k Ohms, with 1k Ohm load to CEC GND, with the divider created between the 3.3V 27k Ohms and the 1k Ohm to CEC GND. And then the current is measured with 3.63V through the 27k Ohms.

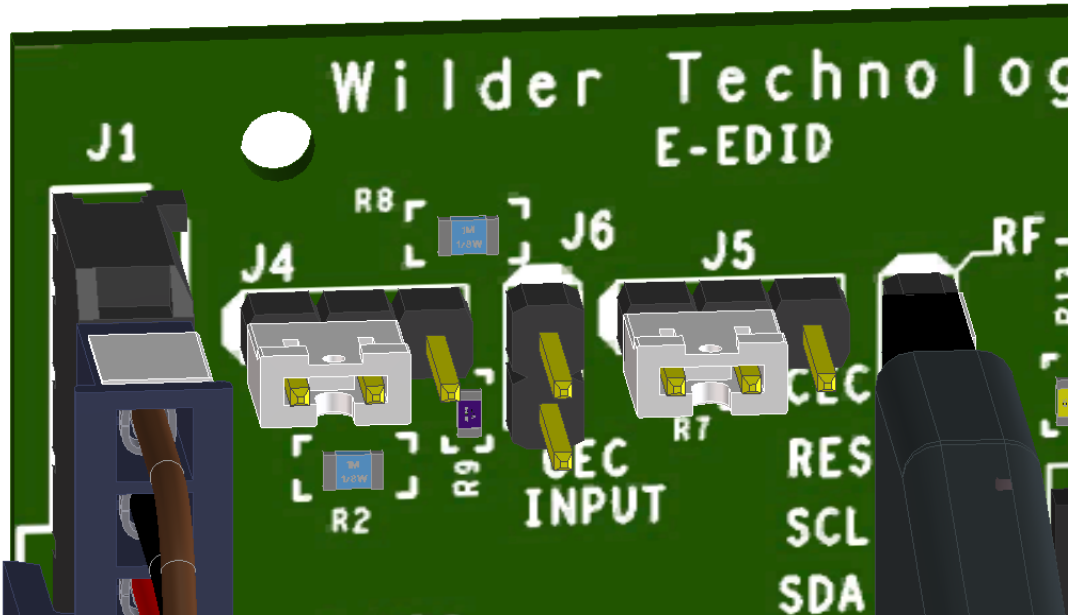

Figure A-7. Jumper positions that connect CEC with a 1 Meg Ohm resistor to DDC/CEC ground on the E-EDID/Low Frequency Control Board.

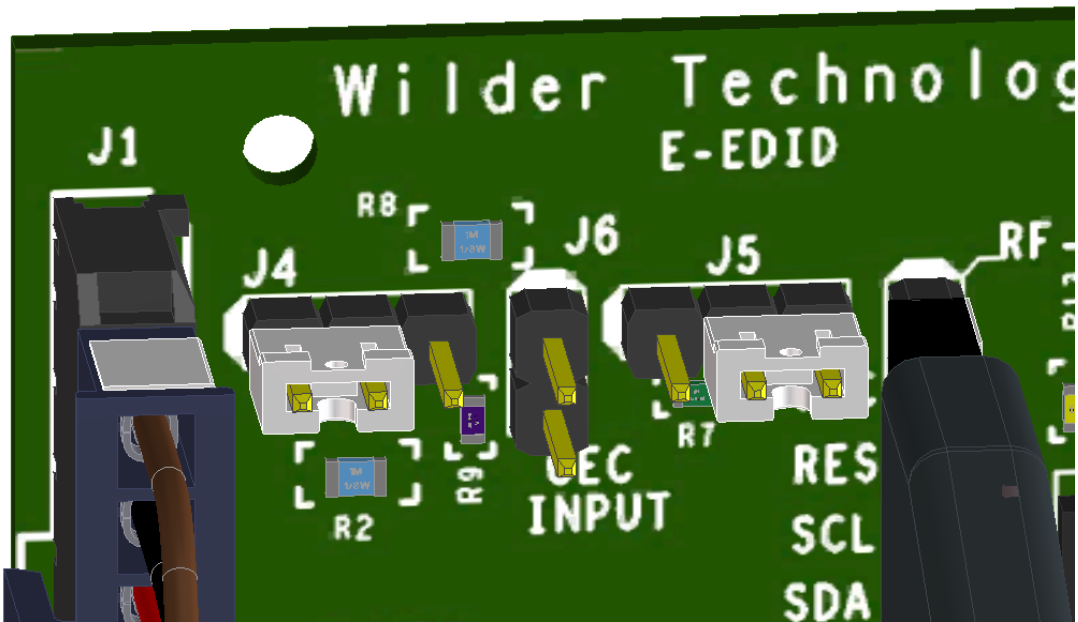

Figure A-8. Jumper positions that connect CEC with a 1k Ohm resistor to DDC/CEC ground on the E-EDID/Low Frequency Control Board.

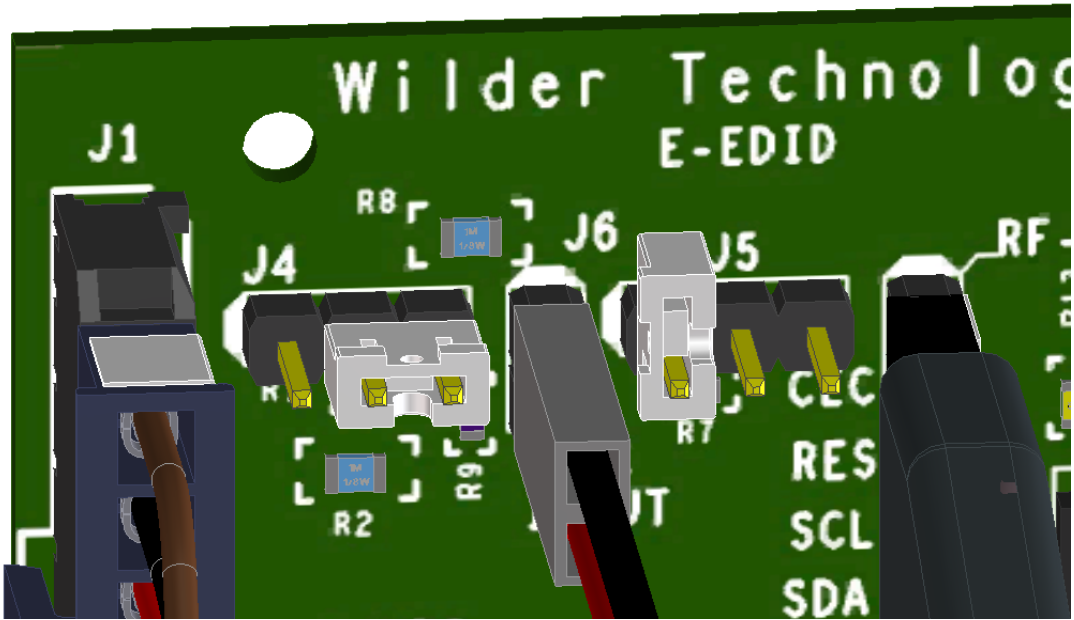

Figure A-9. Jumper positions for CEC power through the 27k Ohm resistor on the E-EDID/Low Frequency Control Board.

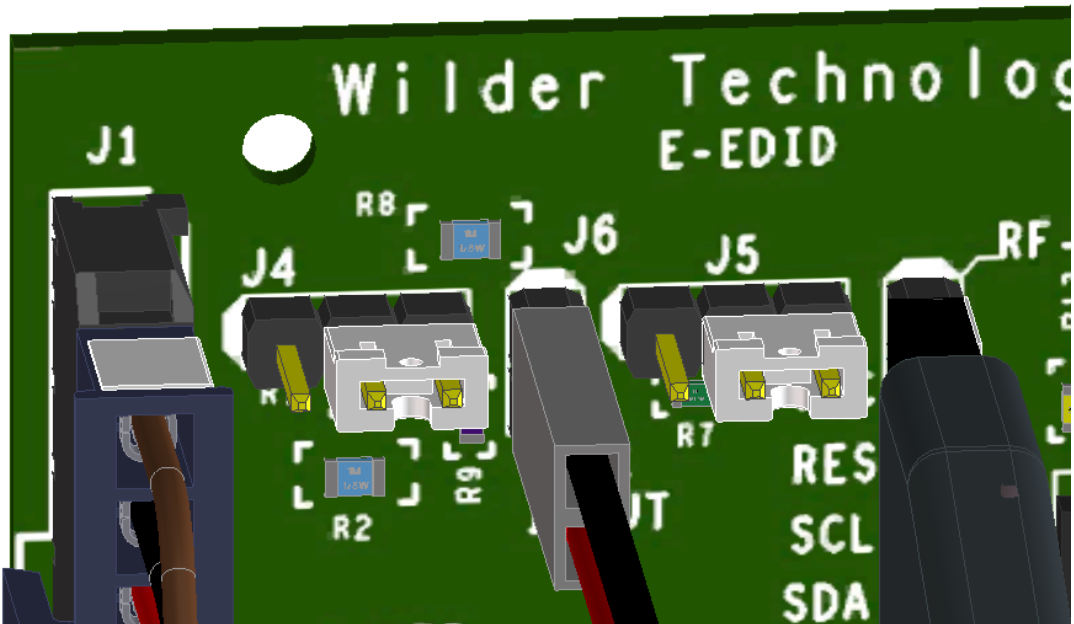

Figure A-10. Jumper positions for CEC power through the 27k Ohm resistor and 1k Ohm resistor to DDC/CEC ground on the E-EDID/Low Frequency Control Board.

E-EDID EE-PROM

Table A-2. E-EDID EE-PROM Memory Map:

	0	1	2	3	4	5	6	7	8	9	A	B	C	D	E	F
00:	00	FF	FF	FF	FF	FF	FF	00	5E	8C	01	00	05	00	00	00
10:	1A	14	01	03	80	50	2D	78	E2	0D	C9	A0	57	47	98	27
20:	12	48	4C	20	00	00	01	01	01	01	01	01	01	01	01	01
30:	01	01	01	01	01	01	01	1D	80	18	71	1C	16	20	58	2C
40:	25	00	C4	8E	21	00	00	9E	8C	0A	D0	8A	20	E0	2D	10
50:	10	3E	96	00	13	8E	21	00	00	18	00	00	00	FC	00	48
60:	44	4D	49	20	54	50	41	0A	20	20	20	20	00	00	00	FD
70:	00	17	F1	08	8C	11	00	0A	20	20	20	20	20	20	01	A4

Block 0

	0	1	2	3	4	5	6	7	8	9	A	B	C	D	E	F
00:	02	03	72	71	83	4F	00	00	73	03	0C	00	10	00	38	21
10:	20	A0	85	01	02	03	04	01	3F	43	45	40	32	0F	7F	07
20:	17	7F	FF	3F	7F	FF	57	7F	00	5F	7F	01	67	7F	00	5F
30:	85	02	03	04	01	06	07	08	09	0A	0B	0C	0D	0E	0F	10
40:	11	12	13	14	15	16	17	18	19	1A	1B	1C	1D	1E	1F	5F
50:	20	21	22	23	24	25	26	27	28	29	2A	2B	2C	2D	2E	2F
60:	30	31	32	33	34	35	36	37	38	39	3A	3B	3C	3D	3E	42
70:	3F	40	00	00	00	00	00	00	00	00	00	00	00	00	00	B0

Block 1

Product ID:

- Manufacturer: WTL
- Model ID: 1
- Serial Number: 5
- Week Made: 26
- Year Made: 2010

EDID Structure:

- EDID Version: 1
- EDID Revision: 3

Video Input Definitions:

- Signal type: Digital
- VESA DFP 1.x default: Not Compatible
- Max Horz Size (in cm): 80
- Max Vert Size (in cm): 45
- Gamma Value: 2.2

Features:

- Standby Mode: Supported
- Suspend Mode: Supported
- Active Off Mode: Supported
- Color Space: Alternate
- Preferred Timing: 1st Detailed

Chromaticity:

- Red_x: 0.625
- Red_y: 0.340
- Green_x: 0.280
- Green_y: 0.595
- Blue_x: 0.155
- Blue_y: 0.070
- White_x: 0.283
- White_y: 0.298

Established Timing 1:

- 640 x 480 @ 60Hz DMT0660

Established Timing 2:

- None

Manufacturer's Timing's:

- None

Standard Timing 1:

- Unused

Standard Timing 2:

- Unused

Standard Timing 3:

- Unused

Standard Timing 4:

- Unused

Standard Timing 5:

- Unused

Standard Timing 6:

- Unused

Standard Timing 7:

- Unused

Standard Timing 8:

- Unused

Preferred Native Descriptor 1:

- Pixel clock (MHz): 74.25
- Horizontal active (pixels): 1920
- Horizontal blanking (pixels): 280
- Vertical active (lines): 540
- Vertical blanking (lines): 22
- Horizontal Sync offset (pixels): 88
- Horizontal Sync pulse width (pixels): 44
- Vertical Sync offset (lines): 2
- Vertical Sync pulse width (lines): 5
- Horizontal image size (mm): 708
- Vertical image size (mm): 398
- Scanning mode: Interlace
- Stereo: Normal display, no stereo
- Sync. mode: Digital Separate, VSYNC polarity +, HSYNC polarity +.

Descriptor 2:

- Pixel clock (MHz): 27.00
- Horizontal active (pixels): 720
- Horizontal blanking (pixels): 138
- Vertical active (lines): 480
- Vertical blanking (lines): 45
- Horizontal Sync offset (pixels): 16
- Horizontal Sync pulse width (pixels): 62
- Vertical Sync offset (lines): 9
- Vertical Sync pulse width (lines): 6
- Horizontal image size (mm): 531
- Vertical image size (mm): 398
- Scanning mode: Non-Interlace
- Stereo: Normal display, no stereo
- Sync. mode: Digital Separate, VSYNC polarity -, HSYNC polarity -.

Display Product Name (ASCII):

- Monitor name: HDMI TPA

Display Range Limits Descriptor:

- Min. vertical rate (Hz): 23
- Max vertical rate (Hz): 241
- Min. horizontal rate (kHz): 8
- Max, horizontal rate (kHz): 140
- Max. clock rate (MHz): 170
- No secondary timing supported.

Timing Extension:

- Tag: 2
- Revision: 3

Monitor Support:

- Underscan: Not supported
- Basic audio: Supported
- RGB and YCbCr444: Supported
- RGB and YCbCr422: Supported

Data Block Collection:

Audio data block:

- Audio format code: Linear PCM (e.g., IEC60958)
- Maximum number of channels: 8
- Sampling frequency (kHz): 32, 44.1, 48, 88.2, 96, 176.4, 192
- Number of bits per sample: 16 bits, 20 bits, 24 bits
- Audio format code: AC-3
- Maximum number of channels: 8
- Sampling frequency (kHz): 32, 44.1, 48, 88.2, 96, 176.4, 192
- Maximum bit rate: 2040 kbps
- Audio format code: DTS
- Maximum number of channels: 8
- Sampling frequency (kHz): 32, 44.1, 48, 88.2, 96, 176.4, 192
- Maximum bit rate: 2040 kbps
- Audio format code: Dolby Digital +
- Maximum number of channels: 8
- Sampling frequency (kHz): 32, 44.1, 48, 88.2, 96, 176.4, 192
- Audio format code: DTS-HD
- Maximum number of channels: 8
- Sampling frequency (kHz): 32, 44.1, 48, 88.2, 96, 176.4, 192
- Audio format code: MAT (MLP)
- Maximum number of channels: 8
- Sampling frequency (kHz): 32, 44.1, 48, 88.2, 96, 176.4, 192

Video data block:

- VIC = 5, Native 1920 x 1080 i 59.94/60Hz 16:9
- VIC = 2, 720 x 480 p 59.94/60Hz 4:3
- VIC = 3, 720 x 480 p 59.94/60Hz 16:9

- VIC = 4, 1280 x 720 p 59.94/60Hz 16:9
- VIC = 1, 640 x 480 p 59.94/60Hz 4:3
- VIC = 6, 720(1440) x 480 i 59.94/60Hz 4:3
- VIC = 7, 720(1440) x 480 i 59.94/60Hz 16:9
- VIC = 8, 720(1440) x 240 p 59.94/60Hz 4:3
- VIC = 9, 720(1440) x 240 p 59.94/60Hz 16:9
- VIC = 10, (2880) x 480 i 59.94/60Hz 4:3
- VIC = 11, (2880) x 480 i 59.94/60Hz 16:9
- VIC = 12, (2880) x 240 p 59.94/60Hz 4:3
- VIC = 13, (2880) x 240 p 59.94/60Hz 16:9
- VIC = 14, 1440 x 480 p 59.94/60Hz 4:3
- VIC = 15, 1440 x 480 p 59.94/60Hz 16:9
- VIC = 16, 1920 x 1080 p 59.94/60Hz 16:9
- VIC = 17, 720 x 576 p 50Hz 4:3
- VIC = 18, 720 x 576 p 50Hz 16:9
- VIC = 19, 1280 x 720 p 50Hz 16:9
- VIC = 20, 1920 x 1080 i 50Hz 16:9
- VIC = 21, 720(1440) x 576 i 50Hz 4:3
- VIC = 22, 720(1440) x 576 i 50Hz 16:9
- VIC = 23, 720(1440) x 288 p 50Hz 4:3
- VIC = 24, 720(1440) x 288 p 50Hz 16:9
- VIC = 25, (2880) x 576 i 50Hz 4:3
- VIC = 26, (2880) x 576 i 50Hz 16:9
- VIC = 27, (2880) x 288 p 50Hz 4:3
- VIC = 28, (2880) x 288 p 50Hz 16:9
- VIC = 29, 1440 x 576 p 50Hz 4:3
- VIC = 30, 1440 x 576 p 50Hz 16:9
- VIC = 31, 1920 x 1080 p 50Hz 16:9
- VIC = 32, 1920 x 1080 p 23.97/24Hz 16:9
- VIC = 33, 1920 x 1080 p 25Hz 16:9
- VIC = 34, 1920 x 1080 p 29.97/30Hz 16:9
- VIC = 35, 2880 x 480 p 59.94/60Hz 4:3
- VIC = 36, 2880 x 480 p 59.94/60Hz 16:9
- VIC = 37, 2880 x 576 p 50Hz 4:3
- VIC = 38, 2880 x 576 p 50Hz 16:9
- VIC = 39, 1920 x 1080 i 50Hz 16:9
- VIC = 40, 1920 x 1080 i 100Hz 16:9
- VIC = 41, 1280 x 720 p 100Hz 16:9
- VIC = 42, 720 x 576 p 100Hz 4:3
- VIC = 43, 720 x 576 p 100Hz 16:9
- VIC = 44, 720(1440) x 576 i 100Hz 4:3
- VIC = 45, 720(1440) x 576 i 100Hz 16:9
- VIC = 46, 1920 x 1080 i 119.88/120Hz 16:9
- VIC = 47, 1280 x 720 p 119.88/120Hz 16:9
- VIC = 48, 720 x 480 p 119.88/120Hz 4:3
- VIC = 49, 720 x 480 p 119.88/120Hz 16:9
- VIC = 50, 720(1440) x 480 i 119.88/120Hz 4:3
- VIC = 51, 720(1440) x 480 i 119.88/120Hz 16:9
- VIC = 52, 720 x 576 p 200Hz 4:3
- VIC = 53, 720 x 576 p 200Hz 16:9

- VIC = 54, 720(1440) x 576 i 200Hz 4:3
- VIC = 55, 720(1440) x 576 i 200Hz 16:9
- VIC = 56, 720 x 480 p 239.76/240Hz 4:3
- VIC = 57, 720 x 480 p 239.76/240Hz 16:9
- VIC = 58, 720(1440) x 480 i 239.76/240Hz 4:3
- VIC = 59, 720(1440) x 480 i 239.76/240Hz 16:9
- VIC = 60, 1280 x 720 p 23.97/24Hz 16:9
- VIC = 61, 1280 x 720 p 25Hz 16:9
- VIC = 62, 1280 x 720 p 29.97/30Hz 16:9
- VIC = 63, 1920 x 1080 p 119.88/120Hz 16:9
- VIC = 64, 1920 x 1080 p 100Hz 16:9

Speaker allocation data block:

- FL/FR LFE FC RL/RR RLC/RRC

Vendor specific data block:

- IEEE registration ID: 0x000C03
- Data block payload: CEC PA 1.0.0.0, 36-bit, 30-bit, deep YCbCr 4:4:4, max TMDS clk: 165 MHz, 3D present (HDMI_3D_LEN = 5), HDMI VICs: {1, 2, 3, 4}, 3D_Structure = 013F
- Number of native formats: 1

Index

- 1X-THRU, 15
- Cable Bend Limits, 6
- Cable Losses, 15
- Cable Tension (Pull Forces), 6
- Cable Twisting (Torque), 6
- Calibration, 13
- Care and Handling, 6
- CEC testing, 42
- Cleaning, 8
- Compliance
 - WEEE, 35
- Connections
 - HDMID-TPA to DUT, 6
 - SMA, 7
- Connector Shell Grounding, 4
- Crosstalk errors, 14
- DDC/CEC Signals
 - +5V Power, 3
 - CEC, 3
 - DDC/CEC Return, 3
 - Ground, 3
 - SCL, 3
 - SDA, 3
- de-emphasis, 15
- Directivity errors, 14
- drift errors, 14
- DUT, 14
- E-EDID EE-PROM, 45
- E-EDID Reference Information, 37
- E-EDID User Model, 40
- E-EDID/Low Frequency Control Board, 3, 16, 37
- Electrical Specifications, 20
- Electrostatic Discharge Information (ESD), 9
- environmental changes, 14
- Errors
 - Crosstalk*, 14
 - Directivity*, 14
 - drift*, 14
 - Load Impedance Mismatching*, 14
 - random*, 14
 - Receiver Reflection-tracking in Test Equipment*, 14
 - Receiver Transmission in Test Equipment*, 14
 - Source Impedance Mismatching*, 14
- ESD protection, 9
- Figures
 - Cable Connectors, 17
 - Calibration module, 13
 - E-EDID and HDMID-TPA-P for non-HEAC testing, 39
 - E-EDID attached to an HDMID-TPA-P, 39
 - E-EDID CEC jumper positions, 43, 44
 - E-EDID connected for sink testing, 41
 - E-EDID connected for source testing, 42
 - E-EDID/Low Frequency Cntrl Board Schematic, 38
 - E-EDID/Low Frequency Control Board, 16, 37
 - The HDMI Type-D HEAC Test Adapter (Plug), 3
 - The HDMI Type-D HEAC Test Adapter (Recept.), 4
- Glossary, 36
- Group delay, 15
- Handling and Storage, 8
- HDMI Compliance Test Specification, 3, 10, 40
- HDMI Type-D HEAC plug as a sink, 10
- HDMI Type-D HEAC plug as a source, 11
- HDMI Type-D HEAC Recepts. as source and sink, 12
- HDMID-TPA Cable Pinout, 17
- HDMID-TPA-E, 16, 37
- HEAC coaxial cable shields, 3
- HEAC optional cable assembly, 4
- HPD sink testing, 41
- HPD source testing, 42
- HPD testing, 40
- Load Impedance Mismatching errors, 14
- low-speed connector, 4
- Low-Speed Connector Part Numbers, 4
- Making Connections, 8
- Mechanical and Environmental Specifications, 17
- Molex Part Numbers, 4
- pre-emphasis, 15
- Product Inspection, 5
- product return, 5
- pull force, 6, 7
- random errors, 14
- Receiver Reflection-tracking in Test Equip. errors, 14
- Receiver Transmission in Test Equipment errors, 14
- secure storage, 5
- SMA cables, 17
- SOLT, 14
- Source Impedance Mismatching errors, 14
- Support, 34
- Supporting Instrument Cables or Accessories, 7
- Tables
 - E-EDID EE-PROM Memory Map, 45
 - E-EDID Electrical Specifications, 40
 - Electrical Specifications, 20
 - General Specifications, 17
 - HDMI Type-D Plug & Recept. Pin Assignments, 19
 - HDMI-TPA Eight Position Cable Connector, 18
 - SMA Cable Connectors (High-Speed), 18
- Terms and Conditions of Sale, 34
- test instrument noise, 14
- test repeatability problems, 14
- User Model Examples, 10, 11, 12
- Visual Inspection, 8
- Warranty, 33
- Web Sites
 - support@wilder-tech.com, 33, 34
 - www.etchrecycling.com, 35
 - www.wilder-tech.com, 33
- WEEE, 35

Visit our website at www.wilder-tech.com



**WILDER
TECHNOLOGIES**

It's all about integrity

Wilder Technologies, LLC
6101A East 18th Street
Vancouver, WA 98661
Phone: 360-859-3041
Fax: 360-859-3105
www.wilder-tech.com

© 2010, 2011 Wilder Technologies, LLC
Document No. 910-0006-000 Rev. C
Created: 8/21/2010 Revised 1/19/2011